

PV+ESS+Charger Solution

User Manual

Issue 02
Date 2023-01-13



Copyright © Huawei Technologies Co., Ltd. 2023. All rights reserved.

No part of this document may be reproduced or transmitted in any form or by any means without prior written consent of Huawei Technologies Co., Ltd.

Trademarks and Permissions



HUAWEI and other Huawei trademarks are trademarks of Huawei Technologies Co., Ltd.

All other trademarks and trade names mentioned in this document are the property of their respective holders.

Notice

The purchased products, services and features are stipulated by the contract made between Huawei and the customer. All or part of the products, services and features described in this document may not be within the purchase scope or the usage scope. Unless otherwise specified in the contract, all statements, information, and recommendations in this document are provided "AS IS" without warranties, guarantees or representations of any kind, either express or implied.

The information in this document is subject to change without notice. Every effort has been made in the preparation of this document to ensure accuracy of the contents, but all statements, information, and recommendations in this document do not constitute a warranty of any kind, express or implied.

Huawei Technologies Co., Ltd.

Address: Huawei Industrial Base
Bantian, Longgang
Shenzhen 518129
People's Republic of China

Website: <https://e.huawei.com>

About This Document

Purpose





This document describes the PV+ESS+Charger Solution in terms of application scenarios, functions, features, cable connections, commissioning, and maintenance. For details about how to install a specific device, see the quick guide or user manual of the device.

Intended Audience

This document is intended for photovoltaic (PV) plant operating personnel and qualified electricians.

Symbol Conventions

The symbols that may be found in this manual are defined as follows.

Symbol	Description
	Indicates a hazard with a high level of risk which, if not avoided, will result in death or serious injury.
	Indicates a hazard with a medium level of risk which, if not avoided, could result in death or serious injury.
	Indicates a hazard with a low level of risk which, if not avoided, could result in minor or moderate injury.
	Indicates a potentially hazardous situation which, if not avoided, could result in equipment damage, data loss, performance deterioration, or other unanticipated results. NOTICE is used to address practices not related to personal injury.
	Supplements the important information in the main text. NOTE is used to address information not related to personal injury, equipment damage, and environment deterioration.

Change History

Issue 02 (2023-01-13)

Updated [2 Solution Overview](#).

Issue 01 (2022-12-02)

This issue is the first official release.

Contents

About This Document.....	ii
1 Safety Information.....	1
1.1 Personal Safety.....	2
1.2 Electrical Safety.....	4
1.3 Environment Requirements.....	8
1.4 Mechanical Safety.....	10
2 Solution Overview.....	14
2.1 Solution Scenarios.....	16
2.2 Solution Functions and Features.....	22
2.2.1 Dynamic Charging Power.....	22
2.2.2 PV Power Preferred.....	25
2.2.3 Charging Settings.....	28
2.2.4 Other Functions.....	30
3 Solution Wiring.....	32
3.1 Three-Phase System.....	33
3.2 Single-Phase System.....	38
4 System Commissioning.....	41
4.1 System Power-On.....	41
4.2 Downloading the FusionSolar App.....	42
4.3 (Optional) Registering an Installer Account.....	42
4.4 Plant Creation and Commissioning (Installer).....	43
4.4.1 Charger-Only.....	44
4.4.2 PV+Charger/PV+ESS+Charger.....	51
4.5 Using a Charger (Owner).....	52
4.5.1 Plug-and-Play Charging.....	52
4.5.2 Scheduled Charging.....	53
4.5.3 Starting and Stopping Charging on the App.....	55
4.5.4 Start Charging Through Bluetooth Authentication.....	56
4.5.5 Starting and Stopping Charging Using an RFID Card.....	58
4.5.6 Charger Settings.....	58
5 Maintenance.....	62

5.1 Troubleshooting.....	62
5.2 Connecting to a Charger.....	70
5.3 Exporting Logs and Performing an Update.....	72
5.4 Resetting Charger Passwords.....	73
5.5 RFID Card Management.....	74
5.6 Restoring Factory Settings.....	76

1 Safety Information

Statement

Before transporting, storing, installing, operating, using, and/or maintaining the equipment, read this document, strictly follow the instructions provided herein, and follow all the safety instructions on the equipment and in this document. In this document, "equipment" refers to the products, software, components, spare parts, and/or services related to this document; "the Company" refers to the manufacturer (producer), seller, and/or service provider of the equipment; "you" refers to the entity that transports, stores, installs, operates, uses, and/or maintains the equipment.

The **Danger, Warning, Caution, and Notice** statements described in this document do not cover all the safety precautions. You also need to comply with relevant international, national, or regional standards and industry practices. **The Company shall not be liable for any consequences that may arise due to violations of safety requirements or safety standards concerning the design, production, and usage of the equipment.**

The equipment should be used in an environment that meets the design specifications. Otherwise, the equipment may be faulty, malfunctioning, or damaged, which is not covered under the warranty. The Company shall not be liable for any property loss, personal injury, or even death caused thereby.

Comply with applicable laws, regulations, standards, and specifications during transportation, storage, installation, operation, use, and maintenance.

Do not perform reverse engineering, decompilation, disassembly, adaptation, implantation, or other derivative operations on the equipment software. Do not study the internal implementation logic of the equipment, obtain the source code of the equipment software, violate intellectual property rights, or disclose any of the performance test results of the equipment software.

The Company shall not be liable for any of the following circumstances or their consequences:

- The equipment is damaged due to force majeure such as earthquakes, floods, volcanic eruptions, debris flows, lightning strikes, fires, wars, armed conflicts, typhoons, hurricanes, tornadoes, and other extreme weather conditions.
- The equipment is operated beyond the conditions specified in this document.

- The equipment is installed or used in environments that do not comply with international, national, or regional standards.
- You fail to follow the operation instructions and safety precautions on the product and in the document.
- You remove or modify the product or modify the software code without authorization.
- You or a third party authorized by you cause the equipment damage during transportation.
- The equipment is damaged due to storage conditions that do not meet the requirements specified in the product document.
- You fail to prepare materials and tools that comply with local laws, regulations, and related standards.
- The equipment is damaged due to your or a third party's negligence, intentional breach, gross negligence, or improper operations, or other reasons not related to the Company.

1.1 Personal Safety

 **DANGER**

Ensure that power is off during installation. Do not install or remove a cable with power on. Transient contact between the core of the cable and the conductor will cause electric arcs, sparks, fire, or explosion, which may result in personal injury.

 **DANGER**

Non-standard and improper operations on the energized equipment may cause fire, electric shocks, or explosion, resulting in property damage, personal injury, or even death.

 **DANGER**

Before operations, remove conductive objects such as watches, bracelets, bangles, rings, and necklaces to prevent electric shocks.

 **DANGER**

During operations, use dedicated insulated tools to prevent electric shocks or short circuits. The dielectric withstanding voltage level must comply with local laws, regulations, standards, and specifications.

 **DANGER**

During operations, wear personal protective equipment such as protective clothing, insulated shoes, goggles, safety helmets, and insulated gloves.

General Requirements

- Do not stop protective devices. Pay attention to the warnings, cautions, and related precautionary measures in this document and on the equipment.
- If there is a likelihood of personal injury or equipment damage during operations, immediately stop, report the case to the supervisor, and take feasible protective measures.
- Do not power on the equipment before it is installed or confirmed by professionals.
- Do not touch the power supply equipment directly or with conductors such as damp objects. Before touching any conductor surface or terminal, measure the voltage at the contact point to ensure that there is no risk of electric shock.
- Do not touch operating equipment because the enclosure is hot.
- Do not touch a running fan with your hands, components, screws, tools, or boards. Otherwise, personal injury or equipment damage may occur.
- In the case of a fire, immediately leave the building or the equipment area and activate the fire alarm or call emergency services. Do not enter the affected building or equipment area under any circumstances.
- Before charging an electric vehicle with the product, read the instructions of the vehicle carefully.
- A generator cannot serve as the power supply for the charger.
- Do not connect the product to devices other than a vehicle.
- Before charging your electric or hybrid vehicle, turn off the car.

Personnel Requirements

- Only professionals and trained personnel are allowed to operate the equipment.
 - Professionals: personnel who are familiar with the working principles and structure of the equipment, trained or experienced in equipment operations and are clear of the sources and degree of various potential hazards in equipment installation, operation, maintenance
 - Trained personnel: personnel who are trained in technology and safety, have required experience, are aware of possible hazards on themselves in certain operations, and are able to take protective measures to minimize the hazards on themselves and other people
- Personnel who plan to install or maintain the equipment must receive adequate training, be able to correctly perform all operations, and understand all necessary safety precautions and local relevant standards.
- Only qualified professionals or trained personnel are allowed to install, operate, and maintain the equipment.

- Only qualified professionals are allowed to remove safety facilities and inspect the equipment.
- Personnel who will perform special tasks such as electrical operations, working at heights, and operations of special equipment should possess the required local qualifications.
- Only certified high-voltage electricians are allowed to operate medium-voltage equipment.
- Only authorized professionals are allowed to replace the equipment or components (including software).
- Only personnel who need to work on the equipment are allowed to access the equipment.

1.2 Electrical Safety

 **DANGER**

Before connecting cables, ensure that the equipment is intact. Otherwise, electric shocks or fire may occur.

 **DANGER**

Non-standard and improper operations may result in fire or electric shocks.

 **DANGER**

Prevent foreign matter from entering the equipment during operations. Otherwise, equipment damage, load power derating, power failure, or personal injury may occur.

 **WARNING**

For the equipment that needs to be grounded, install the ground cable first when installing the equipment and remove the ground cable last when removing the equipment.

General Requirements

- Follow the procedures described in the document for installation, operation, and maintenance. Do not reconstruct or alter the equipment, add components, or change the installation sequence without permission.
- Obtain approval from the national or local electric utility company before connecting the equipment to the grid.
- Observe the power plant safety regulations, such as the operation and work ticket mechanisms.

- Install temporary fences or warning ropes and hang "No Entry" signs around the operation area to keep unauthorized personnel away from the area.
- Before installing or removing power cables, turn off the switches of the equipment and its upstream and downstream switches.
- If any liquid is detected inside the equipment, disconnect the power supply immediately and do not use the equipment.
- Before performing operations on the equipment, check that all tools meet the requirements and record the tools. After the operations are complete, collect all of the tools to prevent them from being left inside the equipment.
- Before installing power cables, check that cable labels are correct and cable terminals are insulated.
- When installing the equipment, use a torque tool of a proper measurement range to tighten the screws. When using a wrench to tighten the screws, ensure that the wrench does not tilt and the torque error does not exceed 10% of the specified value.
- Ensure that bolts are tightened with a torque tool and marked in red and blue after double-check. Installation personnel mark tightened bolts in blue. Quality inspection personnel confirm that the bolts are tightened and then mark them in red. (The marks should cross the edges of the bolts.)

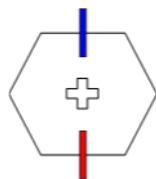

- After the installation is complete, ensure that protective cases, insulation tubes, and other necessary items for all electrical components are in position to avoid electric shocks.
- If the equipment has multiple inputs, disconnect all the inputs before operating the equipment.
- Before maintaining a downstream electrical device supply or power distribution device, turn off the output switch of its power supply equipment.
- During equipment maintenance, attach "Do not switch on" labels near the upstream and downstream switches or circuit breakers as well as warning signs to prevent accidental connection. The equipment can be powered on only after troubleshooting is complete.
- Before fault diagnosis and troubleshooting, take the following safety measures: Disconnect the power supply > Measure the power > Install a ground cable > Hang warning signs and set up fences.
- Do not open equipment panels.
- Check equipment connections periodically, ensuring that all screws are securely tightened.
- Only qualified professionals can replace a damaged cable.
- Do not scrawl, damage, or block any labels or nameplates on the equipment. Promptly replace labels that have worn out.
- Do not use solvents such as water, alcohol, or oil to clean electrical components inside or outside of the equipment.

Grounding

- Ensure that the grounding impedance of the equipment complies with local electrical standards.
- Ensure that the equipment is connected permanently to the protective ground. Before operating the equipment, check its electrical connection to ensure that it is reliably grounded.
- Do not work on the equipment in the absence of a properly installed ground conductor.
- Do not damage the ground conductor.
- For the equipment that uses a three-pin socket, ensure that the ground terminal in the socket is connected to the protective ground point.
- If high touch current may occur on the equipment, ground the protective ground terminal on the equipment enclosure before connecting the power supply; otherwise, electric shock as a result of touch current may occur.

Cabling Requirements

- When selecting, installing, and routing cables, follow local safety regulations and rules.
- When routing power cables, ensure that there is no coiling or twisting. Do not join or weld power cables. If necessary, use a longer cable.
- Ensure that all cables are properly connected and insulated, and meet specifications.
- Ensure that the slots and holes for routing cables are free from sharp edges, and that the positions where cables are routed through pipes or cable holes are equipped with cushion materials to prevent the cables from being damaged by sharp edges or burrs.
- Ensure that cables of the same type are bound together neatly and straight and that the cable sheath is intact. When routing cables of different types, ensure that they are away from each other without entanglement and overlapping.
- When cable connection is completed or paused for a short period of time, seal the cable holes with sealing putty immediately to prevent small animals or moisture from entering.
- Secure buried cables using cable supports and cable clips. Ensure that the cables in the backfill area are in close contact with the ground to prevent cable deformation or damage during backfilling.
- If the external conditions (such as the cable layout or ambient temperature) change, verify the cable usage in accordance with the IEC-60364-5-52 or local laws and regulations. For example, check that the current-carrying capacity meets requirements.
- When routing cables, reserve at least 30 mm clearance between the cables and heat-generating components or areas. This prevents deterioration or damage to the cable insulation layer.
- When the temperature is low, violent impact or vibration may damage the plastic cable sheathing. To ensure safety, comply with the following requirements:
 - Cables can be laid or installed only when the temperature is higher than 0°C. Handle cables with caution, especially at a low temperature.

- Cables stored at subzero temperatures must be stored at room temperature for at least 24 hours before they are laid out.
- Do not perform any improper operations, for example, dropping cables directly from a vehicle. Otherwise, the cable performance may deteriorate due to cable damage, which affects the current-carrying capacity and temperature rise.

ESD

NOTICE

The static electricity generated by human bodies may damage the electrostatic-sensitive components on boards, for example, the large-scale integrated (LSI) circuits.

- When touching the equipment and handling boards, modules with exposed circuit boards, or application-specific integrated circuits (ASICs), observe ESD protection regulations and wear ESD clothing and ESD gloves or a well-grounded ESD wrist strap.

Figure 1-1 Wearing an ESD wrist strap

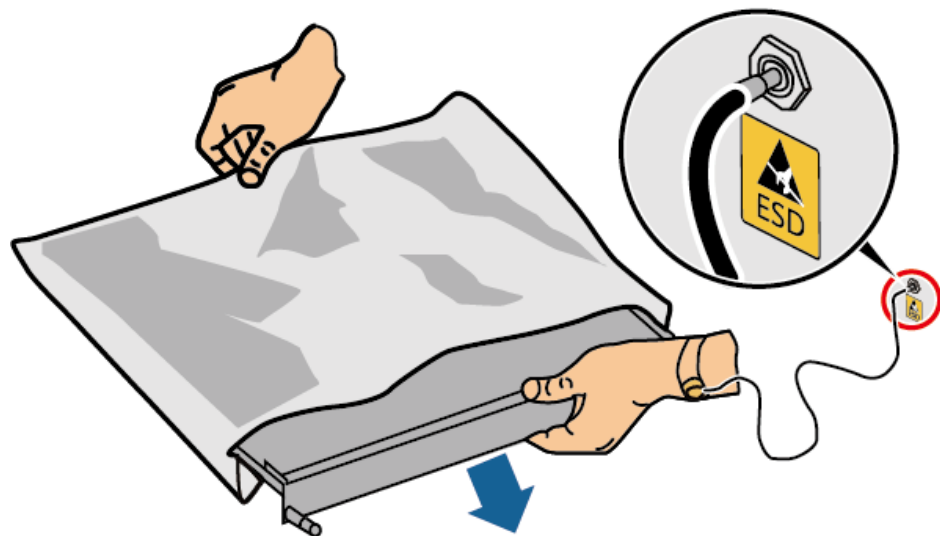

DC15000001

- When holding a board or a module with exposed circuit boards, hold its edge without touching any components. Do not touch the components with bare hands.
- Package boards or modules with ESD packaging materials before storing or transporting them.

1.3 Environment Requirements

 **DANGER**

Do not expose the equipment to flammable or explosive gas or smoke. Do not perform any operation on the equipment in such environments.

 **DANGER**

Do not store any flammable or explosive materials in the equipment area.

 **DANGER**

Do not place the equipment near heat sources or fire sources, such as smoke, candles, heaters, or other heating devices. Overheat may damage the equipment or cause a fire.

 **WARNING**

Install the equipment in an area far away from liquids. Do not install it under areas prone to condensation, such as under water pipes and air exhaust vents, or areas prone to water leakage, such as air conditioner vents, ventilation vents, or feeder windows of the equipment room. Ensure that no liquid enters the equipment to prevent faults or short circuits.

 **WARNING**

To prevent damage or fire due to high temperature, ensure that the ventilation vents or heat dissipation systems are not obstructed or covered by other objects while the equipment is running.

General Requirements

- Ensure that the equipment is stored in a clean, dry, and well ventilated area with proper temperature and humidity and is protected from dust and condensation.
- Do not install or run the equipment beyond the technical specifications. Otherwise, its performance and safety will be compromised.
- Do not install, use, or operate outdoor equipment and cables (including but not limited to moving equipment, operating equipment and cables, inserting connectors to or removing connectors from signal ports connected to outdoor facilities, working at heights, performing outdoor installation, and opening

doors) in harsh weather conditions such as lightning, rain, snow, and level 6 or stronger wind.

- Do not install the equipment in an environment with direct sunlight, dust, smoke, volatile or corrosive gases, infrared and other radiations, organic solvents, or salty air.
- Do not install the equipment in an environment with conductive metal or magnetic dust.
- Do not install the equipment in an area conducive for the growth of microorganisms such as fungus or mildew.
- Do not install the equipment in an area with strong vibration, noise, or electromagnetic interference.
- Ensure that the site complies with local laws, regulations, and related standards.
- Ensure that the ground in the installation environment is solid, free from spongy or soft soil, and not prone to subsidence. The site must not be located in a low-lying land or an area prone to water accumulation, and the horizontal level of the site must be above the highest water level of that area in history.
- Do not install the equipment in a position that may be submerged in water.
- If the equipment is installed in a place with abundant vegetation, in addition to routine weeding, harden the ground underneath the equipment using cement or gravel (recommended area: 3 m x 2.5 m).
- Do not install the equipment outdoors in salt-affected areas because it may be corroded. A salt-affected area refers to the region within 500 m of the coast or prone to sea breeze. Regions prone to sea breeze vary with weather conditions (such as typhoons and monsoons) or terrains (such as dams and hills).
- Before opening doors during the installation, operation, and maintenance of the equipment, clean up any water, ice, snow, or other foreign objects on the top of the equipment to prevent foreign objects from falling into the equipment.
- When installing the equipment, ensure that the installation surface is solid enough to bear the weight of the equipment.
- All cable holes should be sealed. Seal the used cable holes with sealing putty. Seal the unused cable holes with the caps delivered with the equipment. The following figure shows the criteria for correct sealing with sealing putty.

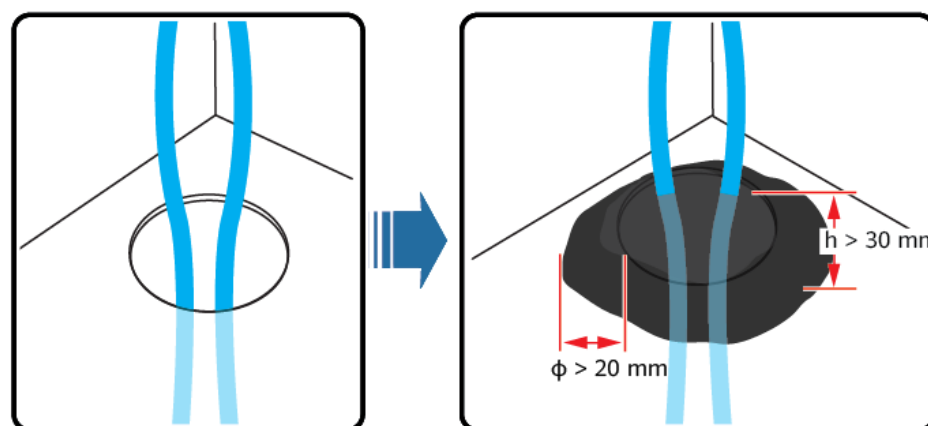

- After installing the equipment, remove the packing materials such as cartons, foam, plastics, and cable ties from the equipment area.

1.4 Mechanical Safety

 DANGER

When working at heights, wear a safety helmet and safety harness or waist belt and fasten it to a solid structure. Do not mount it on an insecure moveable object or metal object with sharp edges. Make sure that the hooks will not slide off.

 WARNING

Ensure that all necessary tools are ready and inspected by a professional organization. Do not use tools that have signs of scratches or fail to pass the inspection or whose inspection validity period has expired. Ensure that the tools are secure and not overloaded.

 WARNING

Do not drill holes into the equipment. Doing so may affect the sealing performance and electromagnetic containment of the equipment and damage components or cables inside. Metal shavings from drilling may short-circuit boards inside the equipment.

General Requirements

- Repaint any paint scratches caused during equipment transportation or installation in a timely manner. Equipment with scratches cannot be exposed for an extended period of time.
- Do not perform operations such as arc welding and cutting on the equipment without evaluation by the Company.
- Do not install other devices on the top of the equipment without evaluation by the Company.
- When performing operations over the top of the equipment, take measures to protect the equipment against damage.
- Use correct tools and operate them in the correct way.

Moving Heavy Objects

- Be cautious to prevent injury when moving heavy objects.

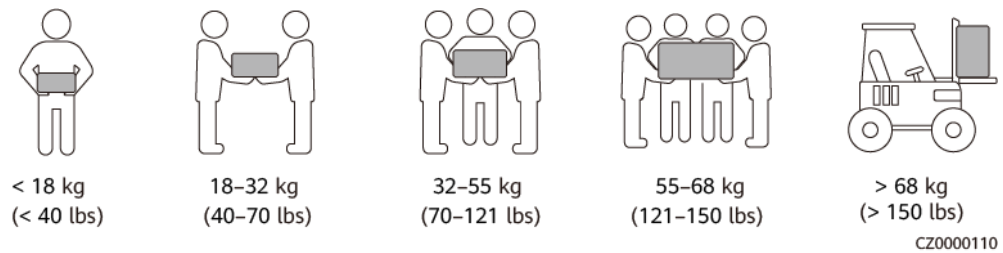

- If multiple persons need to move a heavy object together, determine the manpower and work division with consideration of height and other conditions to ensure that the weight is equally distributed.
- If two persons or more move a heavy object together, ensure that the object is lifted and landed simultaneously and moved at a uniform pace under the supervision of one person.
- Wear personal protective gears such as protective gloves and shoes when manually moving the equipment.
- To move an object by hand, approach to the object, squat down, and then lift the object gently and stably by the force of the legs instead of your back. Do not lift it suddenly or turn your body around.
- Do not quickly lift a heavy object above your waist. Place the object on a workbench that is half-waist high or any other appropriate place, adjust the positions of your palms, and then lift it.
- Move a heavy object stably with balanced force at an even and low speed. Put down the object stably and slowly to prevent any collision or drop from scratching the surface of the equipment or damaging the components and cables.
- When moving a heavy object, be aware of the workbench, slope, staircase, and slippery places. When moving a heavy object through a door, ensure that the door is wide enough to move the object and avoid bumping or injury.
- When transferring a heavy object, move your feet instead of turning your waist around. When lifting and transferring a heavy object, ensure that your feet point to the target direction of movement.
- When transporting the equipment using a pallet truck or forklift, ensure that the tynes are properly positioned so that the equipment does not topple. Before moving the equipment, secure it to the pallet truck or forklift using ropes. When moving the equipment, assign dedicated personnel to take care of it.
- Choose sea or roads in good conditions for transportation as transportation by railway or air is not supported. Avoid tilt or jolt during transportation.

Working at Heights

- Any operations performed 2 meters or higher above the ground should be supervised properly.
- Only trained and qualified personnel are allowed to work at heights.
- Do not work at heights when steel pipes are wet or other risky situations exist. After the preceding conditions no longer exist, the safety owner and relevant technical personnel need to check the involved equipment. Operators can begin working only after safety is confirmed.

- Set a restricted area and prominent signs for working at heights to warn away irrelevant personnel.
- Set guard rails and warning signs at the edges and openings of the area involving working at heights to prevent falls.
- Do not pile up scaffolding, springboards, or other objects on the ground under the area involving working at heights. Do not allow people to stay or pass under the area involving working at heights.
- Carry operation machines and tools properly to prevent equipment damage or personal injury caused by falling objects.
- Personnel involving working at heights are not allowed to throw objects from the height to the ground, or vice versa. Objects should be transported by slings, hanging baskets, highline trolleys, or cranes.
- Do not perform operations on the upper and lower layers at the same time. If unavoidable, install a dedicated protective shelter between the upper and lower layers or take other protective measures. Do not pile up tools or materials on the upper layer.
- Dismantle the scaffolding from top down after finishing the job. Do not dismantle the upper and lower layers at the same time. When removing a part, ensure that other parts will not collapse.
- Ensure that personnel working at heights strictly comply with the safety regulations. The Company is not responsible for any accident caused by violation of the safety regulations on working at heights.
- Do not loiter when working at heights. Do not rest in the area involving working at heights.

Using Ladders

- Use wooden or insulated ladders when you need to perform live-line working at heights.
- Platform ladders with protective rails are preferred. Single ladders are not recommended.
- Before using a ladder, check that it is intact and confirm its load bearing capacity. Do not overload it.
- Ensure that the ladder is securely positioned and held firm.



CZ00000107

- When climbing up the ladder, keep your body stable and your center of gravity between the side rails, and do not overreach to the sides.
- When a step ladder is used, ensure that the pull ropes are secured.

- If a single ladder is used, the recommended angle for the ladder against the floor is 75 degrees, as shown in the following figure. A square can be used to measure the angle.

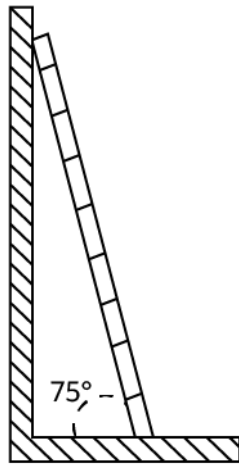

PI02SC0008

- If a single ladder is used, ensure that the wider end of the ladder is at the bottom, and take protective measures to prevent the ladder from sliding.
- If a single ladder is used, do not climb higher than the fourth rung from the top.
- If you use a single ladder to climb up to a platform, ensure that the ladder is at least 1 m higher than the platform.

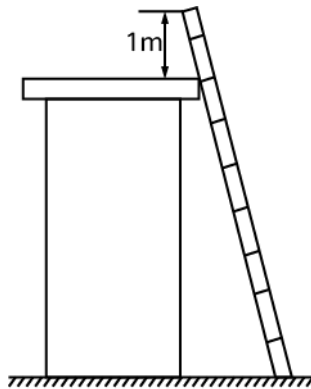

PI02SC0009

Drilling Holes

- Obtain consent from the customer and contractor before drilling holes.
- Wear protective equipment such as safety goggles and protective gloves when drilling holes.
- To avoid short circuits or other risks, do not drill holes into buried pipes or cables.
- When drilling holes, protect the equipment from shavings. After drilling, clean up any shavings.

2 Solution Overview

The PV+ESS+Charger Solution integrates the PV system and energy storage system (ESS) with a charger to charge vehicles, which also helps save electricity costs through peak and off-peak electricity price differences. The charger implements dynamic charging power based on the power information delivered by the management system and the grid-connection point power information reported by the meter. The solution includes the inverter, ESS, optimizer, AC charger, meter, management system, and FusionSolar app.

Product Introduction

Table 2-1 Product list

Component	Model	Description
Inverter	SUN2000-(2KTL-6KTL)-L1 SUN2000-(5KTL-12KTL)-M1 SUN2000-(8KTL-20KTL)-M2	<ul style="list-style-type: none"> When an inverter is configured, PV power can be used for charging vehicles.
ESS	LUNA2000-(5-30)-S0	<ul style="list-style-type: none"> 5 kWh per battery module, system capacity up to 30 kWh when two ESSs are cascaded
AC charger	SCharger-7KS-S0 (single-phase) SCharger-22KT-S0 (three-phase)	<ul style="list-style-type: none"> Multiple charging modes are available.
Backup Box	Backup Box-B0 (single-phase) Backup Box-B1 (three-phase)	<ul style="list-style-type: none"> On/Off-grid scenarios are supported.

Component	Model	Description
Smart Power Sensor (RS485)	DDSU666-H DTSU666-H	<ul style="list-style-type: none"> Connects to the inverter over RS485 for output power management and power limiting control. It can also be used for dynamic charging power through virtual meter networking.
Smart Power Sensor (FE)	DDSU666-FE	<ul style="list-style-type: none"> Controls dynamic charging power.
Smart Dongle	WLAN/FE Dongle 4G Dongle	<ul style="list-style-type: none"> Connects to the management system and performs power scheduling.
Smart PV Optimizer	SUN2000-450W-P2 SUN2000-600W-P	<ul style="list-style-type: none"> Long and short input cables are available to connect to PV modules with different cable lengths.

References

For details about the installation, cable connection, and configuration of the products in the network, see the following documents.

Table 2-2 Reference documents

Category	Link
Charger	FusionCharge AC User Manual
Cable connection for Residential Smart PV	FusionSolar Residential Smart PV Quick Guide (Three-phase PV+Storage Scenario and Smart Dongle Networking)
Single-phase inverter	SUN2000-(2KTL-6KTL)-L1 Quick Guide
Three-phase inverter	SUN2000-(3KTL-10KTL)-M1 Quick Guide
	SUN2000-(8KTL-20KTL)-M2 Quick Guide
ESS	LUNA2000-(5-30)-S0 Quick Guide
Backup Box	Backup Box-(B0, B1) Quick Guide

Category	Link
Smart Dongle	SDongleA-05 Smart Dongle Quick Guide (WLAN-FE) SDongleB-06 Smart Dongle Quick Guide (4G)
Meter	DTSU666-H 100 A and 250 A Smart Power Sensor User Manual DDSU666-H Smart Power Sensor User Manual For details about the DTSU666-FE Smart Power Sensor, see the quick guide delivered with the product.
Optimizer	SUN2000-(600 W-P, 450 W-P2) Smart PV Optimizer Quick Guide
FusionSolar app	FusionSolar App Quick Guide (Charge) FusionSolar App User Manual

2.1 Solution Scenarios

Meter Configuration Description

- In the PV+ESS+Charger Solution, the charger compares the grid-connection point information reported by the meter with the total current setting of the main circuit breaker to quickly adjust the charging power and prevent the main circuit breaker from tripping. When **PV Power Preferred** is enabled and the meter detects that the PV system has surplus power, the charger uses the surplus power for vehicle charging and implement dynamic charging power based on the PV yield.
- The charger supports two meter connection modes.
 FE meter: The DTSU666-FE can be connected.
 Virtual meter: The data of the RS485 meter can be sent to the charger through the WLAN/FE Smart Dongle to implement dynamic charging power.

Figure 2-1 Meter connection modes (using a three-phase inverter as an example)

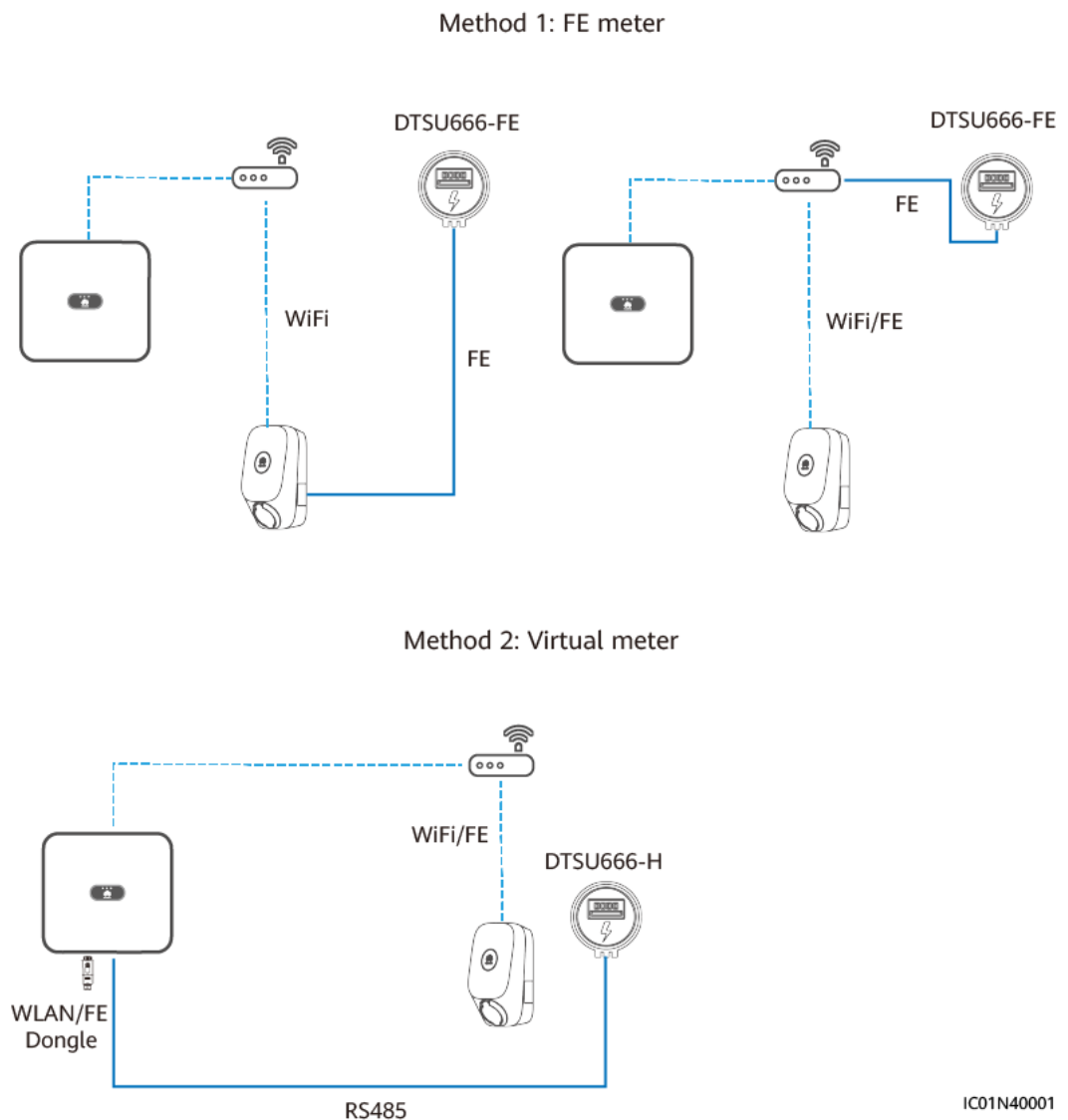

Based on meter connection modes and PV device configuration, the installation scenarios are classified into Charger-only, PV+Charger (FE meter), PV+Charger/PV+ESS+Charger (RS485 meter & WLAN/FE Smart Dongle), and PV+Charger/PV+ESS+Charger (RS485 meter & FE meter & non-WLAN/FE Smart Dongle).

Table 2-3 Scenario features

Scenario	Grid-Connection Point Power Limit	PV Device	Meter Connection Mode	PV Power Preferred	Dynamic Charging Power
Charger-only	×	×	FE meter	×	√
PV+Charger (FE meter)	×	√	FE meter	√	√

Scenario	Grid-Connection Point Power Limit	PV Device	Meter Connection Mode	PV Power Preferred	Dynamic Charging Power
PV+Charger/PV+ESS +Charger (RS485 meter & WLAN/FE Smart Dongle)	√	√	Virtual meter	√	√
PV+Charger/PV+ESS +Charger (RS485 meter & FE meter & non-WLAN/FE Smart Dongle)	√	√	FE meter	√	√

The following table lists the device configurations in different scenarios.

Table 2-4 Product configuration

Scenario	Charger	Huawei Inverter	ESS	WLAN/FE-Dongle	FE meter	RS485 meter
Charger-only	√	×	×	×	Optional	×
PV+Charger (FE meter)	√	√	×	Optional	√	×
PV+Charger/PV+ESS +Charger (RS485 meter & WLAN/FE Smart Dongle)	√	√	Optional	√	×	√
PV+Charger/PV+ESS +Charger (RS485 meter & FE meter & non-WLAN/FE Smart Dongle)	√	√	Optional	×	√	√

Charger-Only

- The **PV Power Preferred** mode is not supported in charger-only scenarios.
- To implement dynamic charging power, a meter needs to be configured. The meter can be directly connected to the charger through the FE port or connected to the charger through a router.
- When the charger is connected to the router through WiFi, ensure that the WiFi signal is good and there is no obstacle around the devices. Otherwise, the meter may be disconnected and dynamic charging power cannot be implemented.

Figure 2-2 Charger FE port directly connected to a meter

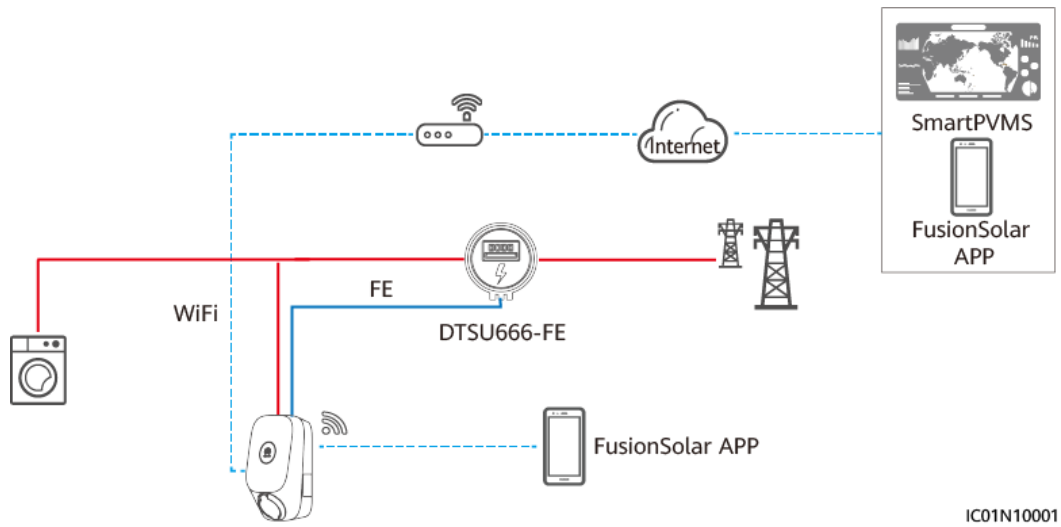
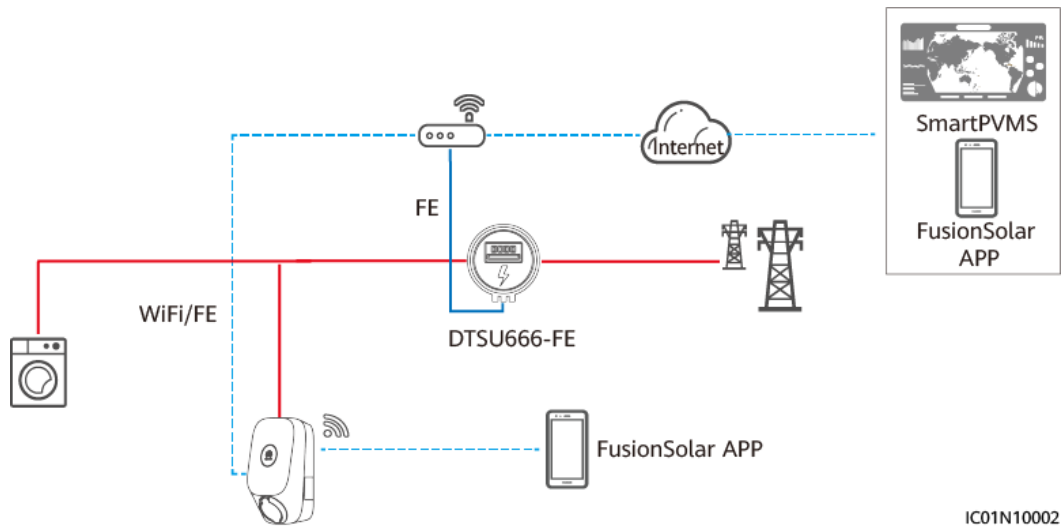

Figure 2-3 Charger connected to a router through WiFi/FE



NOTE

- When the charger is connected to a router through WiFi or FE, the FE meter must be connected to the same router.
- If other FE meters are connected to the router at the same time, the dynamic charging power of the charger may be abnormal. In this case, you are advised to connect the charger to the FE meter through a network cable.

PV+Charger (FE Meter)

- To implement PV power preferred and dynamic charging power, the FE meter is mandatory.

Figure 2-4 PV+Charger (charger directly connected to a FE meter)

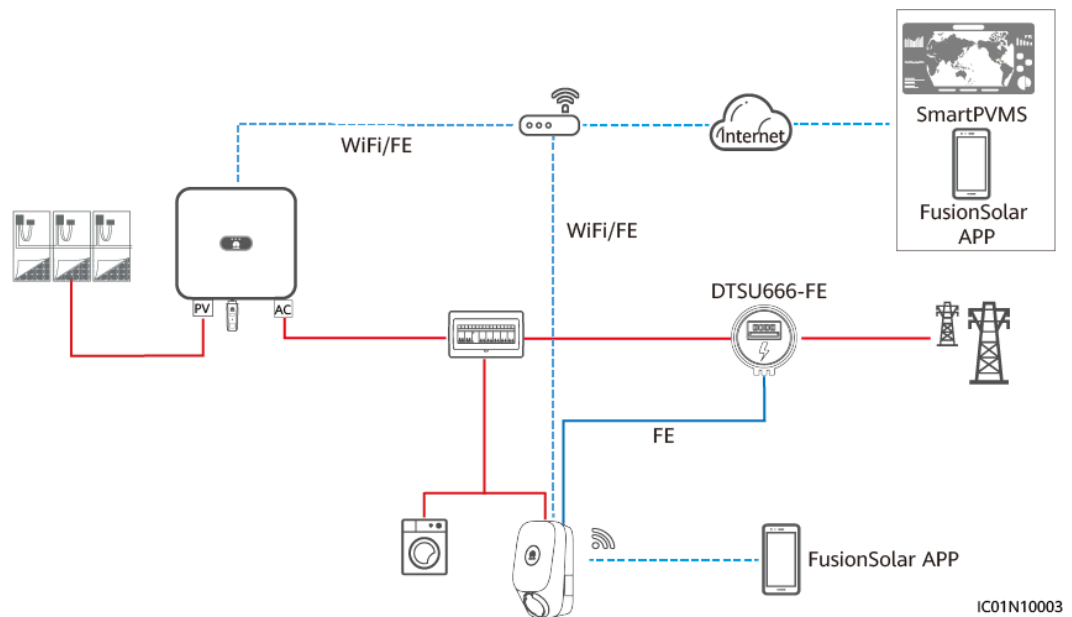

NOTE

- If an FE power meter and a WLAN/FE Smart Dongle are configured, disable Modbus TCP of the WLAN/FE Smart Dongle to ensure that the charger power control is normal. (Modbus TCP is disabled by default. For details about the setting, see [4.4.2 PV +Charger/PV+ESS+Charger](#).) Otherwise, the communication between the charger and meter will be interrupted.
- When the charger is connected to a router through WiFi or FE, the FE meter must be connected to the same router.
- If other FE meters are connected to the router at the same time, the dynamic charging power of the charger may be abnormal. In this case, you are advised to connect the charger to the FE meter through a network cable.

PV+Charger/PV+ESS+Charger (RS485 meter & WLAN/FE Smart Dongle)

- If the RS485 meter and WLAN/FE Smart Dongle are configured, the RS485 meter data can be sent to the charger through the WLAN/FE Smart Dongle to implement the virtual meter networking.
- If the grid-connection point of the plant has power limit requirements and there is a meter, a charger is required and the virtual meter networking solution is recommended. The power at the grid-connection point must be higher than **Surplus Power to Start Charging**. Otherwise, the charger cannot start charging in **PV Power Preferred** mode and stays waiting to charge.
- If the plant is set to zero feed-in, the charger cannot start charging in **PV Power Preferred** mode and stays waiting to charge.
- To support the virtual meter networking, the WLAN/FE Smart Dongle needs to be upgraded to SDongle V100R001C00SPC133 or SDongle V200R022C10SPC100.

Figure 2-5 PV+Charger/PV+ESS+Charger (RS485 meter & FE meter & WLAN/FE Smart Dongle)

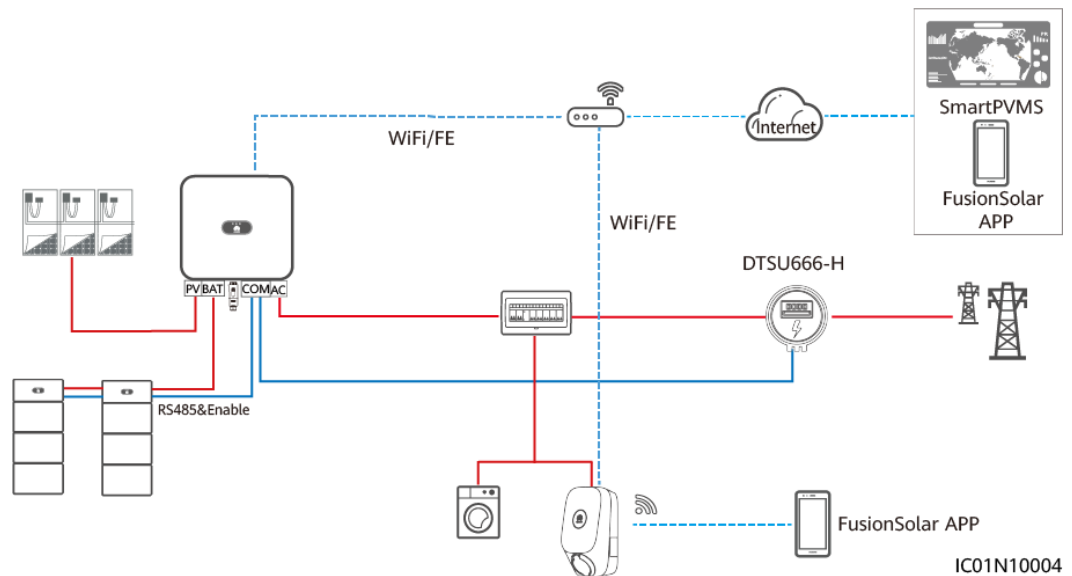

NOTE

- The WLAN/FE Smart Dongle sends meter data to the charger through Modbus TCP. When virtual meter networking is used, set the Modbus TCP parameter of the WLAN/FE Smart Dongle to **Enable (unrestricted)**. For details, see [4.4.2 PV+Charger/PV+ESS+Charger](#).
- If the charger uses virtual meter networking, the WLAN/FE Smart Dongle cannot connect to a third-party management system using Modbus TCP at the same time.
- If the charger uses virtual meter networking, one router can connect to only one WLAN/FE Smart Dongle. If two WLAN/FE Smart Dongles are connected to the same router, communication will be interrupted, resulting in abnormal charger power control. In this case, you need to connect the WLAN/FE Smart Dongles to two routers respectively for grid connection.
- The SUN2000-(2KTL-6KTL)-L1 cannot directly connect to the router through WLAN to implement the virtual meter function. In this case, you need to install the WLAN/FE Smart Dongle.

PV+Charger/PV+ESS+Charger (RS485 meter & FE meter & non-WLAN/FE Smart Dongle)

- If the plant cannot use the WLAN/FE Smart Dongle or the SUN2000-(2KTL-6KTL)-L1 is directly connected to the router, the dual-meter networking solution can be used. The RS485 meter is used to monitor the grid-connection point information of the PV+ESS system, and the FE meter is used for dynamic charging power.
- If the grid-connection point of the plant has power limit requirements, the power of the grid-connection point must be higher than the minimum startup power of the charger. Otherwise, the charger cannot start charging in **PV Power Preferred** mode and stays waiting to charge.
- If the plant is set to zero feed-in, the charger cannot start charging in **PV Power Preferred** mode and stays waiting to charge.

- If no installation space is available for a meter, use a WLAN/FE Smart Dongle and the virtual meter networking solution.

Figure 2-6 PV+Charger/PV+ESS+Charger (RS485 meter & FE meter & non-WLAN/FE Smart Dongle, using charger directly connected to an FE meter as an example)

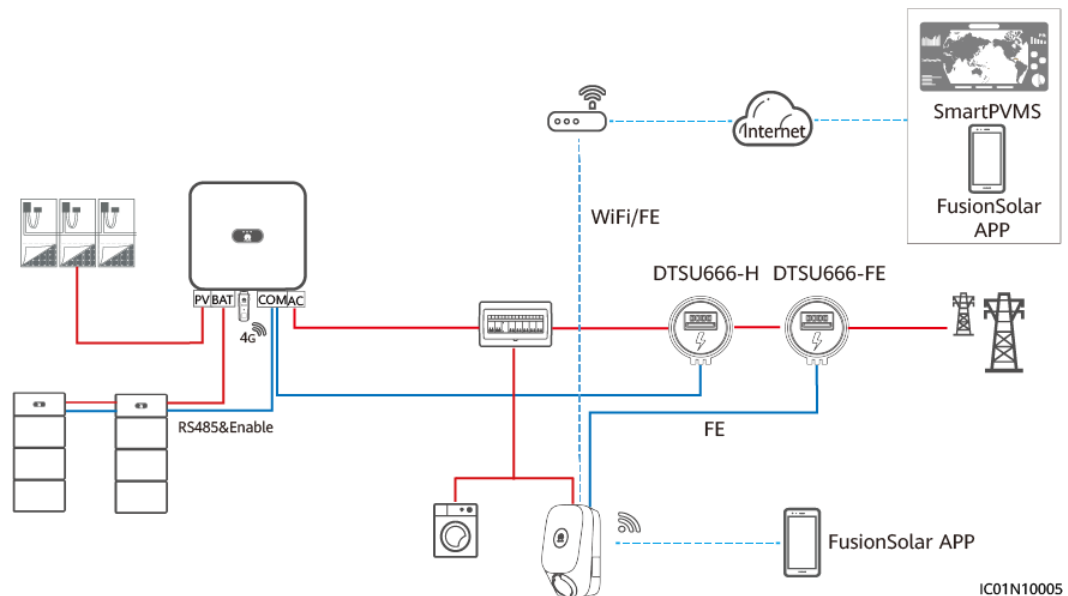

NOTE

- When the charger is connected to a router through WiFi or FE, the FE meter must be connected to the same router.
- If the charger is connected to the FE meter and the router does not have enough ports to connect the charger, meter, and all the inverters, you can connect the charger and FE meter to other routers.

2.2 Solution Functions and Features

2.2.1 Dynamic Charging Power

NOTE

- Set **Main Circuit Breaker Capacity** based on the site requirements. If the setting is greater than the actual value, the circuit breaker trips due to overcurrent. If the setting is less than the actual value, the charger cannot start charging.
- If the load of the home appliances and charger exceeds 150% of the rated capacity of the main circuit breaker, the dynamic charging power function may not respond in time. In this case, replace the main circuit breaker with that of a larger capacity.

Feature Description

- The charger compares the grid-connection current reported by the meter with the current of the main circuit breaker to implement dynamic charging power and prevent the main circuit breaker from tripping.

- A meter must be configured for the dynamic charging power function. When the charger detects that the meter is disconnected, it switches to the minimum current charging mode. You can also set **Charging current if charger is disconnected from meter** as needed.

Parameter Settings (Installer)

When creating a PV plant, log in to the FusionSolar app as an installer, [connect to the charger](#), tap **Setup Wizard** on the home screen, and set **Main Circuit Breaker Capacity** on the quick settings screen.

Figure 2-7 Quick settings



Alternatively, [connect to the charger](#) as an installer, set **Main Circuit Breaker Capacity** and **Charging current if charger is disconnected from meter** on the maintenance screen.

Figure 2-8 Installer settings

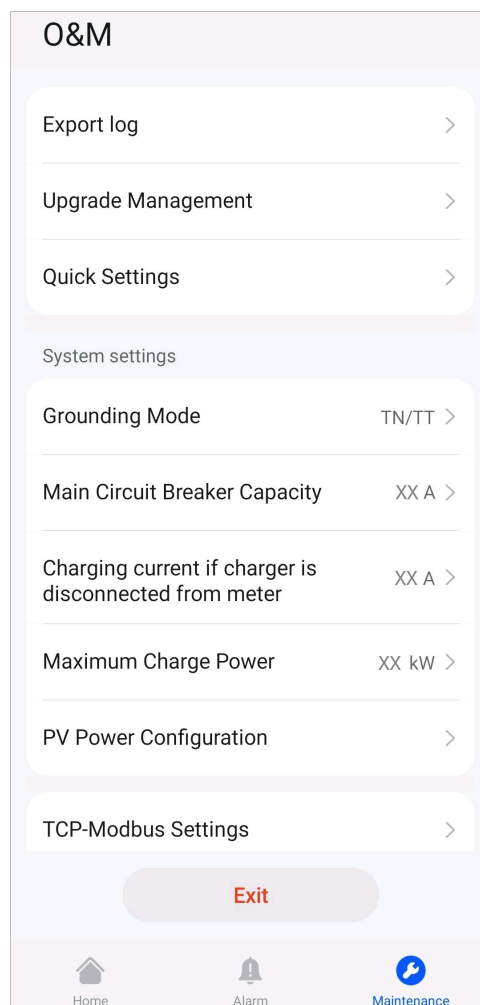

Parameter Settings (Owner)

Connect to the charger as an owner, choose **Settings > Advanced Settings**, and set **Main Circuit Breaker Capacity** and **Charging current if charger is disconnected from meter**.

Figure 2-9 Owner settings

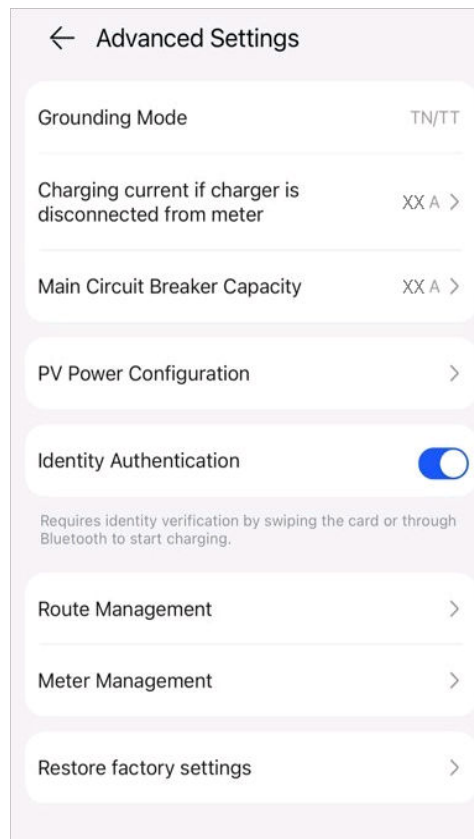

2.2.2 PV Power Preferred

NOTE

PV Power Preferred is displayed only when the PV+ESS system and charger are connected to the same plant.

Feature Description

- In addition to the power supplied to home appliances and ESS, if the surplus PV power is greater than the setting of **Surplus Power to Start Charging**, the charger starts charging.
- In the **PV Power Preferred** mode, after the charger starts charging, the actual charging power is related to the surplus PV power and the setting of **Max Charging Power from Grid**.
 - When the surplus PV power is greater than **Max Charging Power from Grid**, the charger uses the surplus PV power to charge the vehicle.
 - When **Max Charging Power from Grid** is greater than the surplus PV power, the charger charges the vehicle at **Max Charging Power from Grid**. The deficiency is supplemented by the power grid.
- The minimum charging power of a single-phase charger is about 1.38 kW*. You are advised to set **Max Charging Power from Grid** of the single-phase charger to a value greater than 1.38 kW. Otherwise, charging will be interrupted when the PV power is low.

Table 2-5 Example of single-phase charging power (**Max Charging Power from Grid \geq 1.38 kW**)

Surplus PV Power (a)	Max Charging Power from Grid (b)	Actual Charging Power (a or b, Whichever is Larger)
3	2	3 (PV)
1.5	2	1.5 (PV) + 0.5 (grid)
0.5	2	0.5 (PV) + 1.5 (grid)
0	2	2 (grid)

Table 2-6 Example of single-phase charging power (**Max Charging Power from Grid $<$ 1.38 kW**)

Surplus PV Power (a)	Max Charging Power from Grid (b)	Actual Charging Power (a or b, Whichever is Larger)
3	0–1.38	3 (PV)
1.5	0–1.38	1.5 (PV)
1.4	0–1.38	1.4 (PV)
1.3	0–1.38	Charging stops (if a or b, whichever is larger, is less than 1.38 kW).

- The minimum charging power of a three-phase charger is about 4.14 kW*.
 - To improve PV energy utilization rate, if a vehicle has both three-phase and single-phase charging capabilities, the three-phase charger can use the single-phase and three-phase switching function. When the charging power of the three-phase charger decreases to less than 4.14 kW, the charger automatically switches to single-phase charging.
 - You are advised to set **Max Charging Power from Grid** of the three-phase charger to a value greater than 1.38 kW when the single-or three-phase switching is enabled and to a value greater than 4.14 kW when the single-or three-phase switching is disabled. Otherwise, charging will be interrupted when the PV power is low.

 **NOTE**

- Note*: The minimum operating current of a charger is 6 A. When the voltage is 230 V, the charging power of a single-phase charger is 1.38 kW, and that of a three-phase charger is 4.14 kW.
- The following uses a single-phase charger as an example: The default values of **Surplus Power to Start Charging** and **Max Charging Power from Grid** are 1.4 kW. If the voltage is high, increase the values based on the actual voltage. Otherwise, if the actual voltage is greater than 230 V, the operating current of the charger is less than 6 A at the default values and charging will stop.

Setting PV Power Parameters

Log in to the FusionSolar app as an owner, tap the charger icon on the home screen, choose **Settings** > **Advanced Settings** > **PV Power Configuration**, and set related parameters.

- **Max Charging Power from Grid:** maximum power that the charger can draw from the power grid during charging in PV power mode.
- **Surplus Power to Start Charging:** When the PV feed-in power is greater than this set value, the charger starts to charge the vehicle.
- **Switch Between Single and Three Phases:** When the charge power of a three-phase charger is low, the charger can switch to single-phase charging. You are advised to enable this function in PV scenarios to increase the PV energy utilization rate.

Enabling PV Power Preferred (Charge Now)

Log in to the FusionSolar app as an owner, tap the charger icon on the home screen, and enable **PV Power Preferred** on the **Settings** screen. A green icon is displayed on **Charge Now**.

Figure 2-10 Enabling PV power preferred

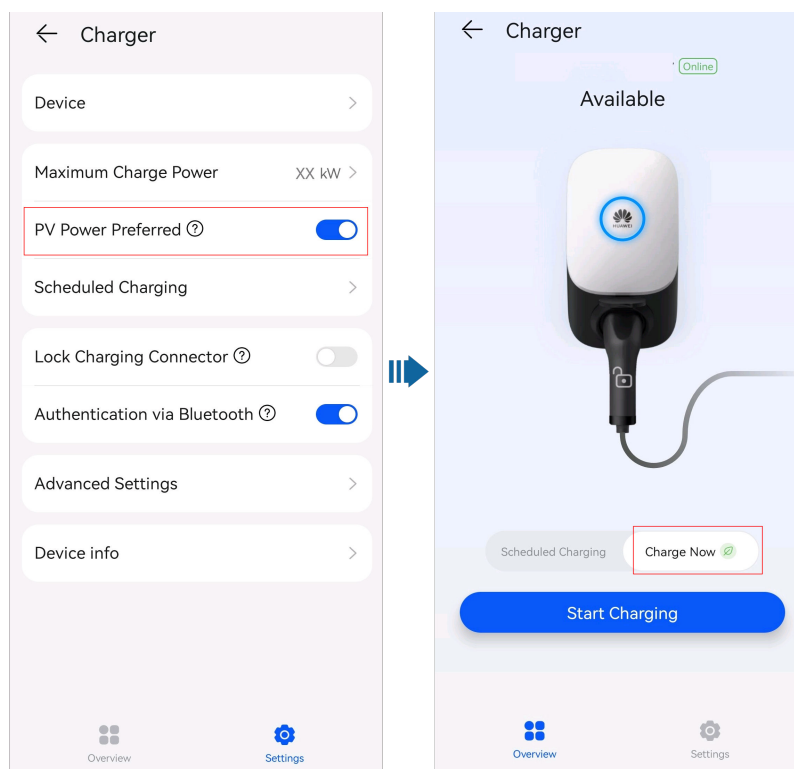

Enabling PV Power Preferred (Scheduled Charging)

Log in to the FusionSolar app as an owner, tap the charger icon on the home screen, tap **Settings** > **Scheduled Charging**, add a scheduled time period, and enable the **PV Power Preferred** mode in the period.

Figure 2-11 Setting the scheduled time period

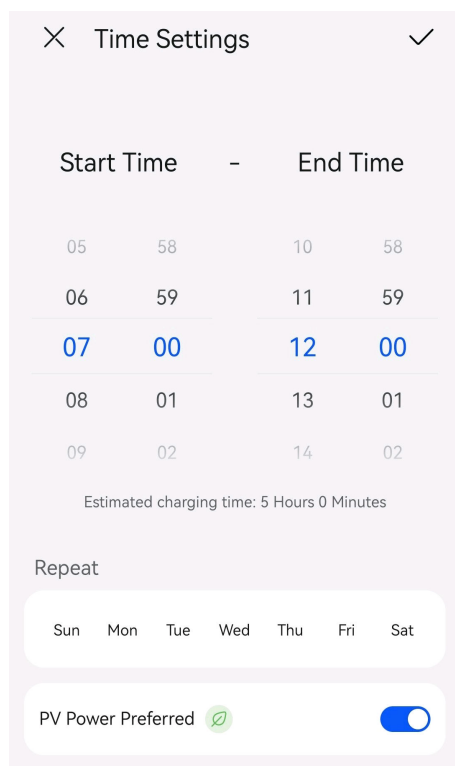

2.2.3 Charging Settings

Charging Mode

Log in to the FusionSolar app as an owner, tap the charger icon on the home screen, and set the charging mode to **Charge Now** or **Scheduled Charging**.

Figure 2-12 Charging mode settings

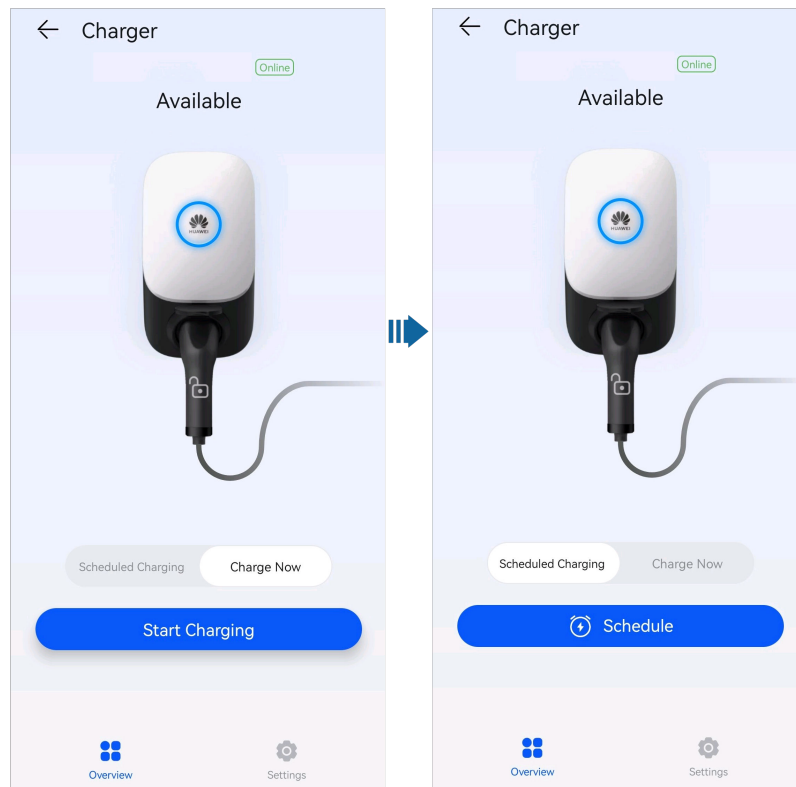

- **Charge Now:** The charger charges the vehicle immediately after startup. You can set whether to use the **PV Power Preferred** function. For details, see [Enabling PV Power Preferred \(Charge Now\)](#).
- **Scheduled Charging:** The charger starts to charge the vehicle when the scheduled time is reached. You need to set the scheduled time period and determine whether to enable **PV Power Preferred** in the period. For details, see [Enabling PV Power Preferred \(Scheduled Charging\)](#).

Figure 2-13 Adding scheduled time periods

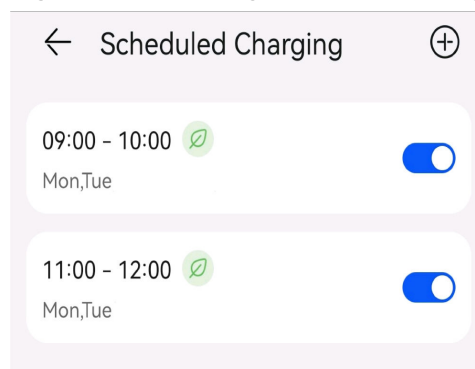

Identity Authentication

- Log in to the FusionSolar app as an owner, tap the charger icon on the home screen, choose **Settings > Advanced Settings**, and enable **Identity Authentication**. Then, start charging using the app, Bluetooth, or RFID card. For details, see [Using a Charger](#).

Figure 2-14 Enabling identity authentication

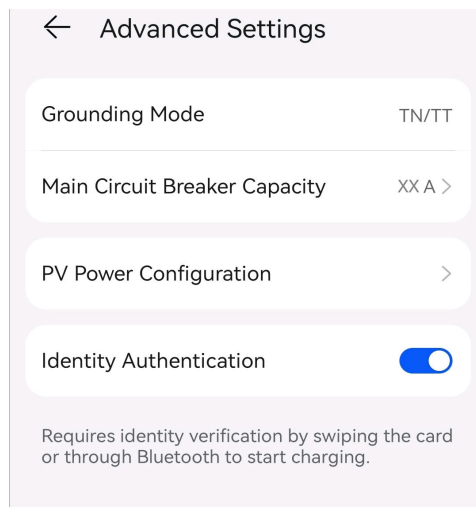

- When **Identity Authentication** is disabled, the charger automatically starts charging after the charging connector is inserted into the charging port of a vehicle.

 **NOTE**

Unauthorized charging may occur if **Identity Authentication** is disabled.

2.2.4 Other Functions

Lock Charging Connector

You can also lock the charging connector to the charger if the property safety is ensured. In this way, you only need to insert the charging connector to your vehicle to start a charging session.

1. On the charger screen, tap **Settings**.
2. Enable **Lock Charging Connector**.



Grounding Self-Check

In a TN/TT system, the charger can detect the ground impedance of the neutral wire and PE wire to ensure that the device is properly grounded. If the grounding

is abnormal, an alarm is generated. The grounding self-check function is disabled by default in an IT system.

Virtual Plug-In of Charging Connector

A vehicle enters the sleep state when waiting to charge for a long time. When charging starts, the charger wakes up the vehicle by simulating the signal of charging connector insertion and removal to ensure that the charging is normal. If the vehicle does not support CP signal wakeup, the vehicle cannot be woken up for charging after dynamic charging power is performed for overload protection or when the charging conditions are met in scheduled charging or PV power preferred mode.

3 Solution Wiring

This document provides only device wiring diagrams. For details about communications port definitions and wiring, see the user manual of the corresponding device.

3.1 Three-Phase System

Charger-Only

Figure 3-1 Charger directly connected to a meter

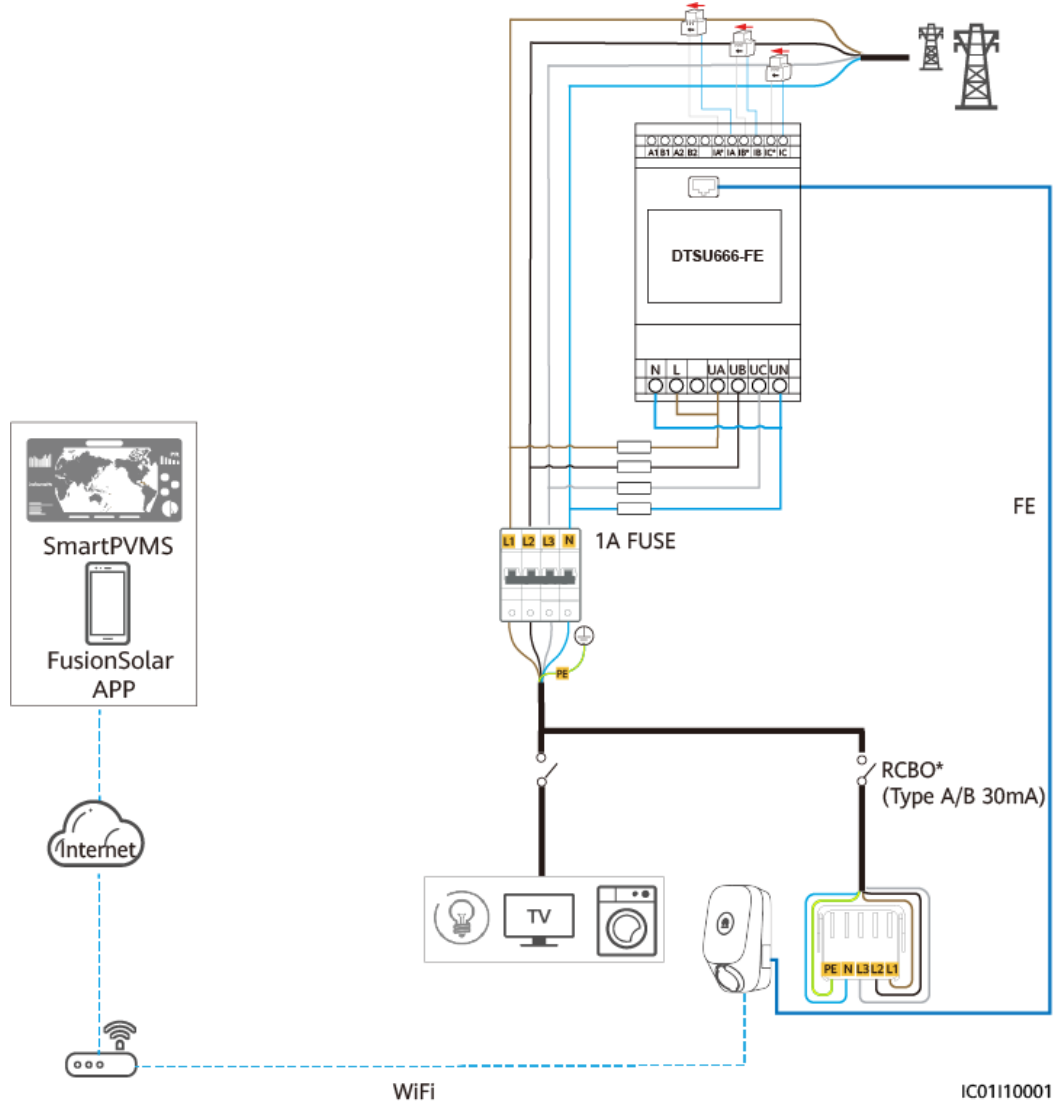
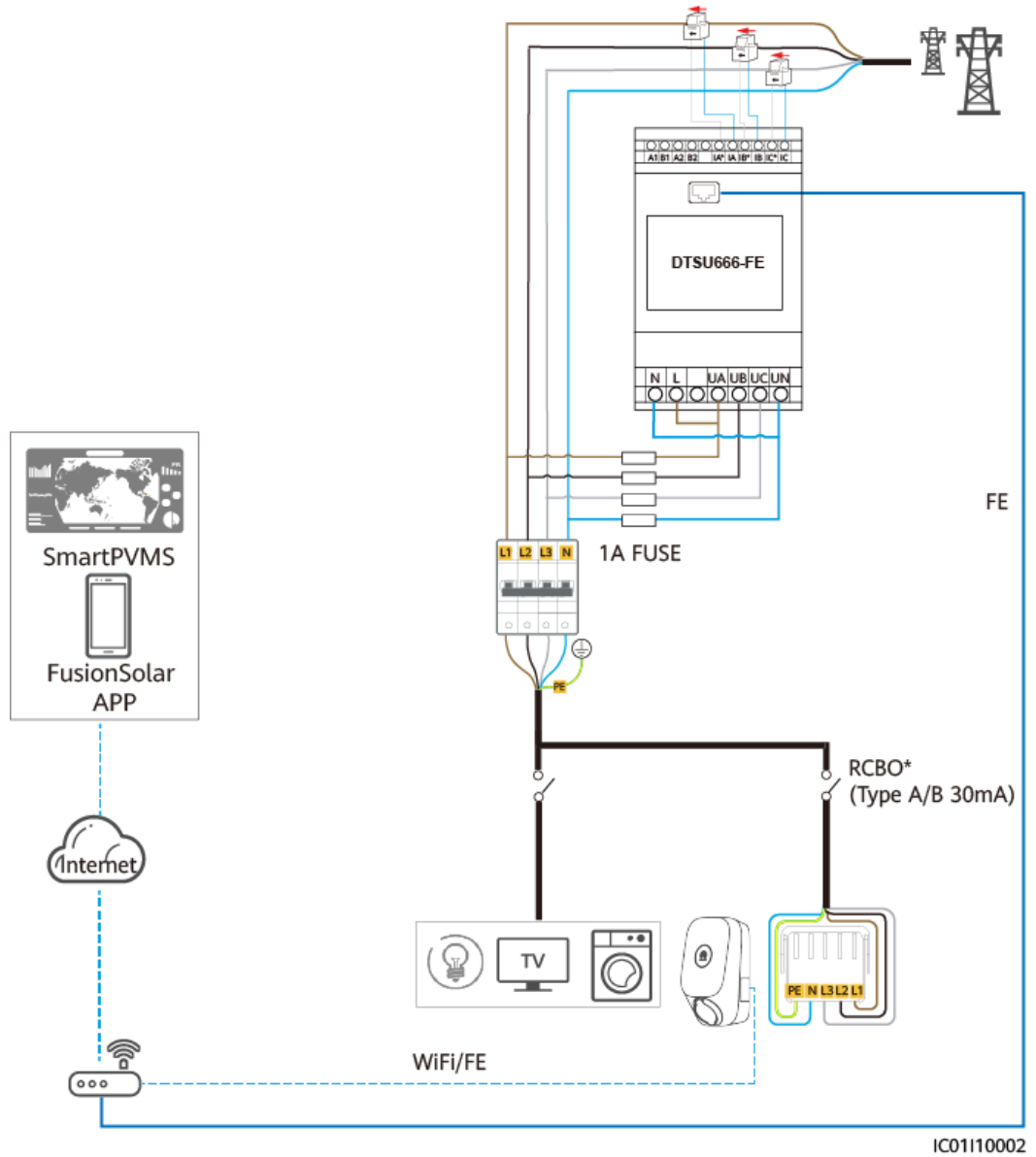
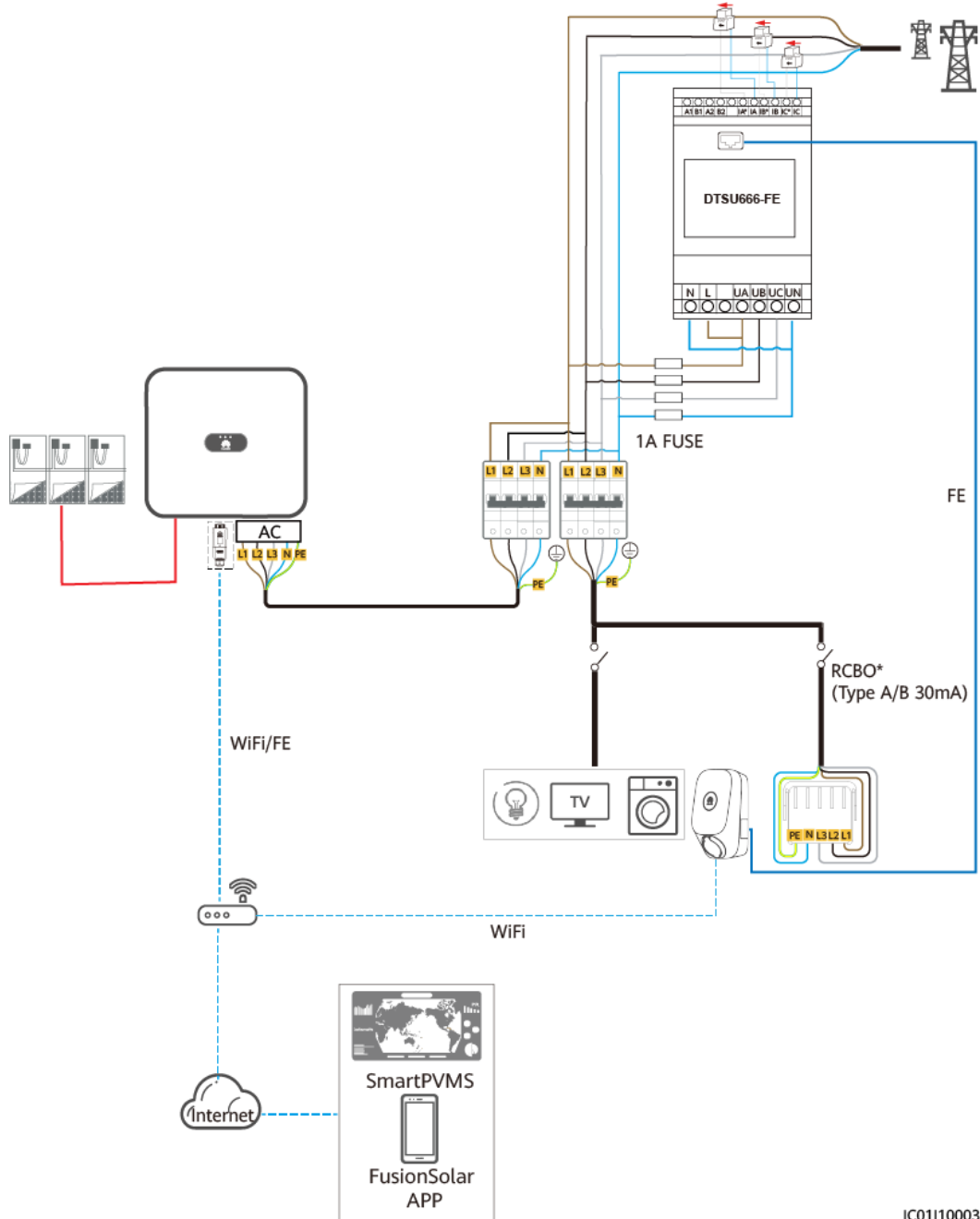

Figure 3-2 Charger connected to a router through the FE port or WiFi



PV+Charger (FE meter)

Figure 3-3 PV+Charger (FE meter, using WLAN/FE Smart Dongle as an example)



IC01110003

PV+Charger/PV+ESS+Charger (RS485 meter & WLAN/FE Smart Dongle)

Figure 3-4 PV+Charger/PV+ESS+Charger (RS485 meter & WLAN/FE Smart Dongle)

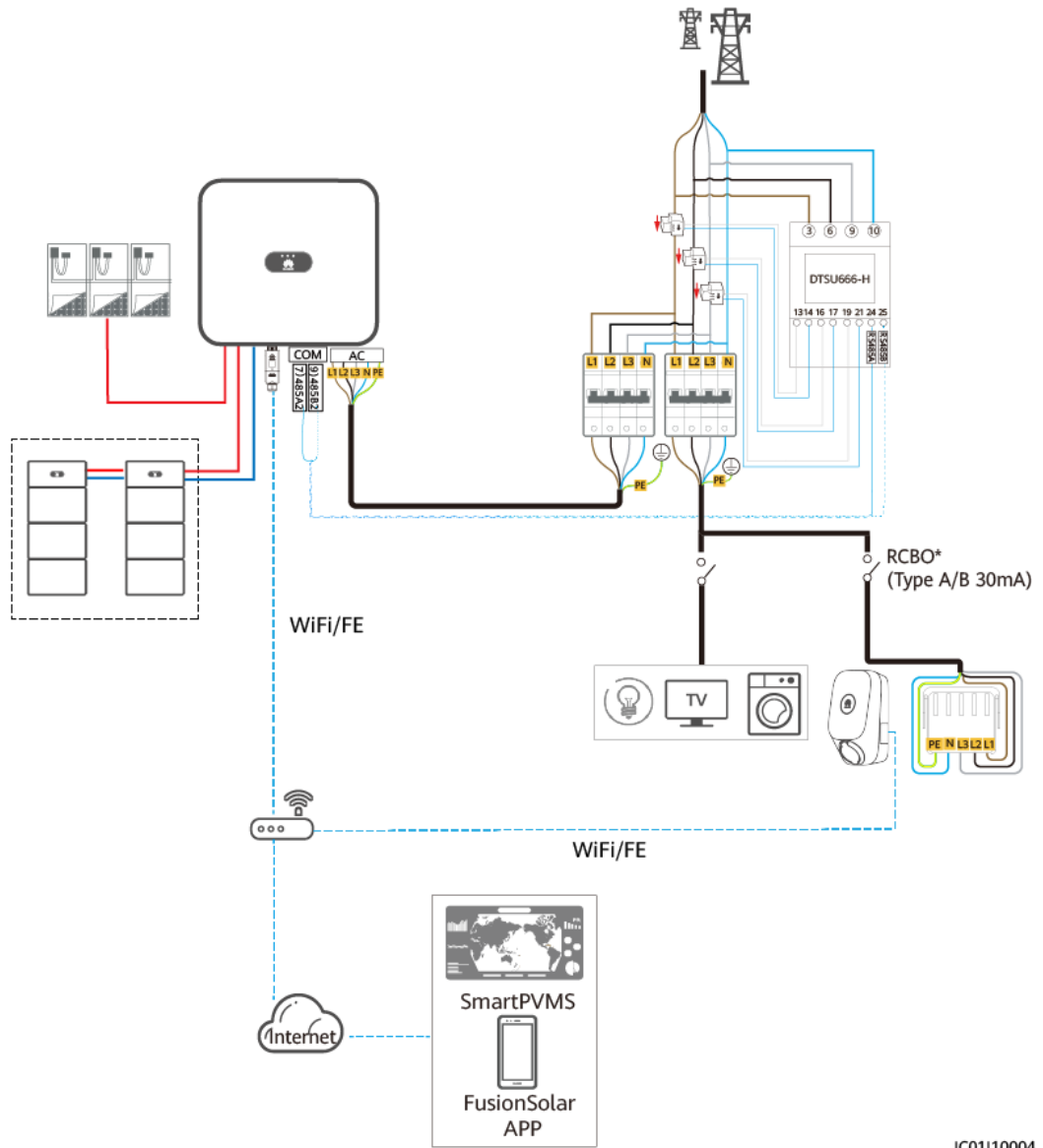

IC01110004

PV+Charger/PV+ESS+Charger (RS485 meter & FE meter & non-WLAN/FE Smart Dongle)

Figure 3-5 PV+Charger/PV+ESS+Charger (RS485 meter & FE meter & non-WLAN/FE Smart Dongle)

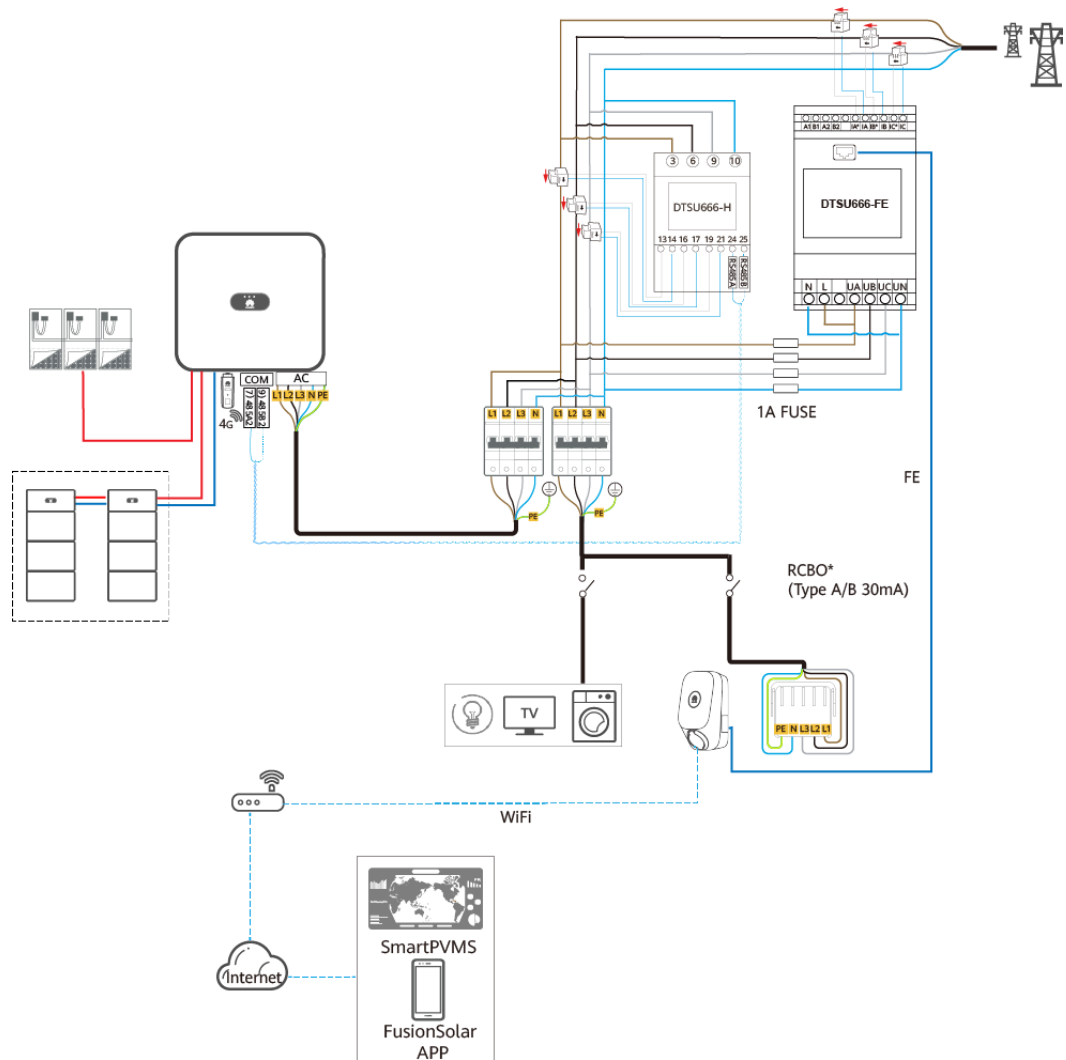

IC0110005

NOTE

When the three-phase charger is switched to single-phase charging, the L1 phase is used for power supply. To ensure that the single-phase and three-phase switching does not affect the load of the single-phase wire, it is recommended that the L1 phase of the charger be connected to the phase wire with the minimum load. The wiring of the meter should be the same as that of the charger.

Figure 3-6 Connecting charger L1 to the phase wire with the minimum load

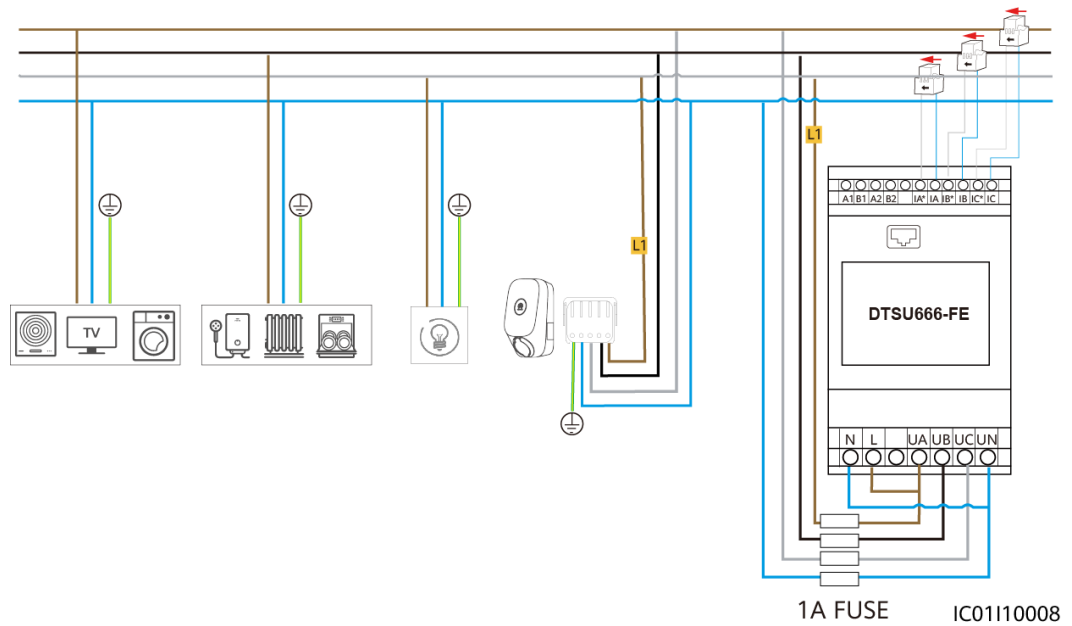

NOTE

- You are advised to install a fuse on the voltage input side of the meter.
- Note*: A residual current circuit breaker with overcurrent protection (RCBO) needs to be installed at the upstream of the charger. The recommended specifications are as follows: 4P/40 A (50 A when the ambient temperature is greater than 45°C), Type A or B, complying with local laws and regulations.

3.2 Single-Phase System

In the single-phase system wiring diagram, both FE and RS485 meters are connected as an example.

Figure 3-7 Single-phase system wiring diagram (TN & TT single-phase)

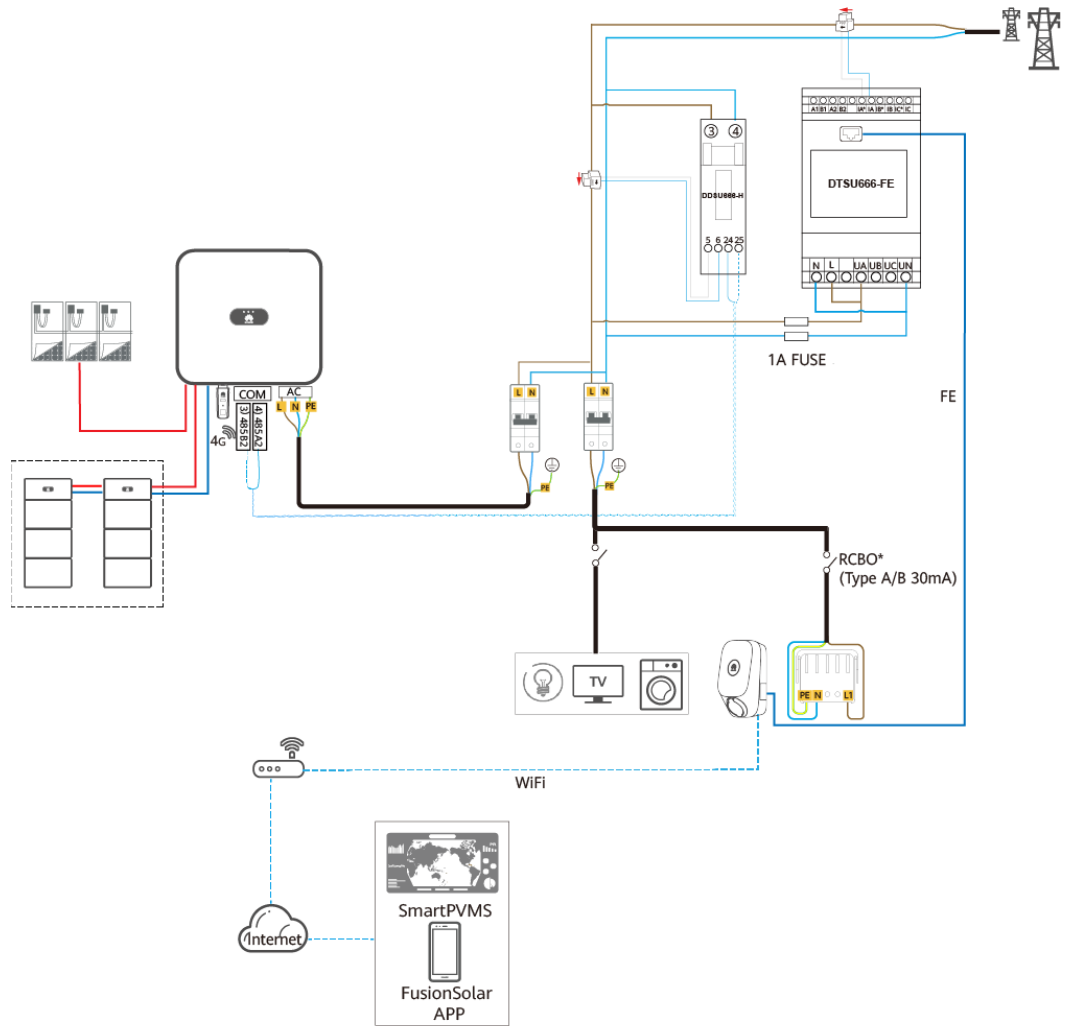

IC01110006

Figure 3-8 Single-phase system wiring diagram (230 V L-L)

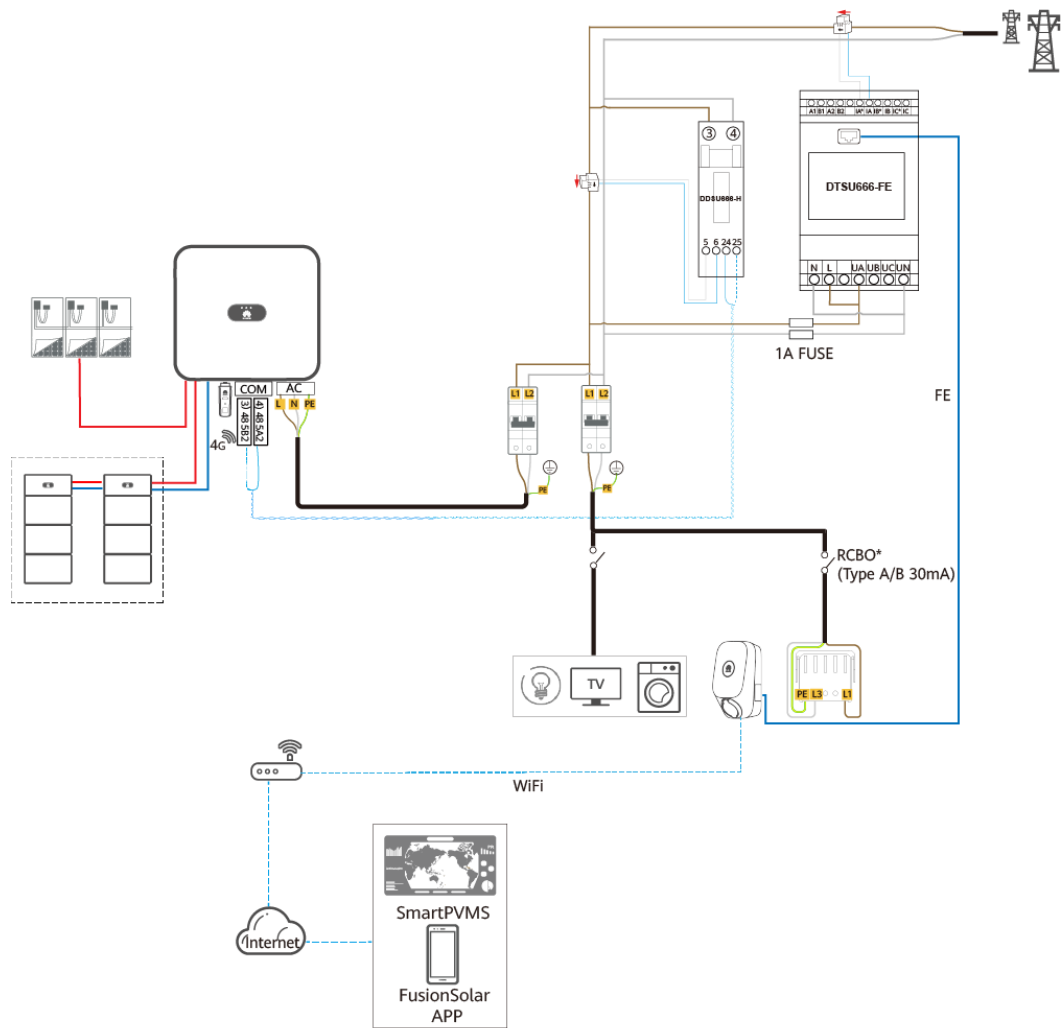

IC01110007

NOTE





- You are advised to install a fuse on the voltage input side of the meter.
- Note*: An RCBO needs to be installed at the upstream of the charger. The recommended specifications are as follows: 2P/40 A (50 A when the ambient temperature is greater than 45°C), Type A or B, complying with local laws and regulations.

4 System Commissioning

4.1 System Power-On

1. Power on the PV+ESS system. For details, see the corresponding user manuals.
2. Turn on the upstream switch (RCBO) of the charger.

Table 4-1 Charger indicator description

Indicator	Indicator Status	Charger Status
 Blue	Cycle: steady blue for 4s and off for 1s	Charging connector plugged (The authentication function is disabled.)
	Cycle: pulsating blue for 1s	Charging in progress
	Steady blue	Charging ended (The charging connector is not removed.)
	Cycle: pulsating blue for 4s and off for 1s	Scheduled charging waiting
 White	Cycle: pulsating white for 4s and off for 1s	Idle (default state or charging connector removed from the vehicle)
	Cycle: flashing white for 0.5s	Upgrading
 Green	Cycle: pulsating green for 1s	PV power charging waiting and PV power charging in progress
 Red	Cycle: flashing red for 0.5s	Alarming
	Steady red	Faulty

4.2 Downloading the FusionSolar App

- Method 1: Access <https://solar.huawei.com> using the mobile phone browser and download the latest installation package.

Figure 4-1 Download Mode

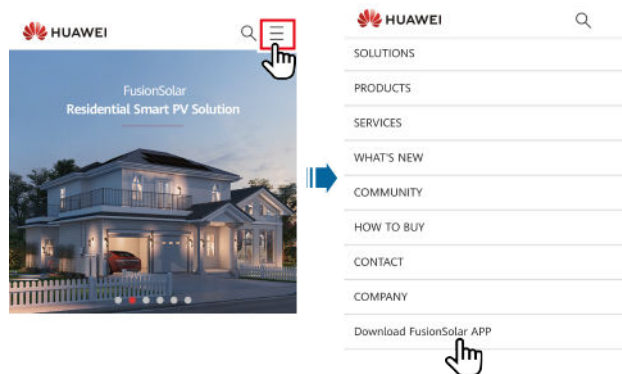

- Method 2: Search for FusionSolar on Huawei AppGallery and download the latest installation package.
- Method 3: Scan the following QR code and download the latest installation package.

Figure 4-2 QR code



FusionSolar

4.3 (Optional) Registering an Installer Account

NOTE

- If you have an installer account, skip this step.
- You can register an account only using a mobile phone only in China.
- The mobile number or email address used for registration is the user name for logging in to the FusionSolar App.

Create the first installer account and create a domain named after the company name.

Figure 4-3 Creating the first installer account

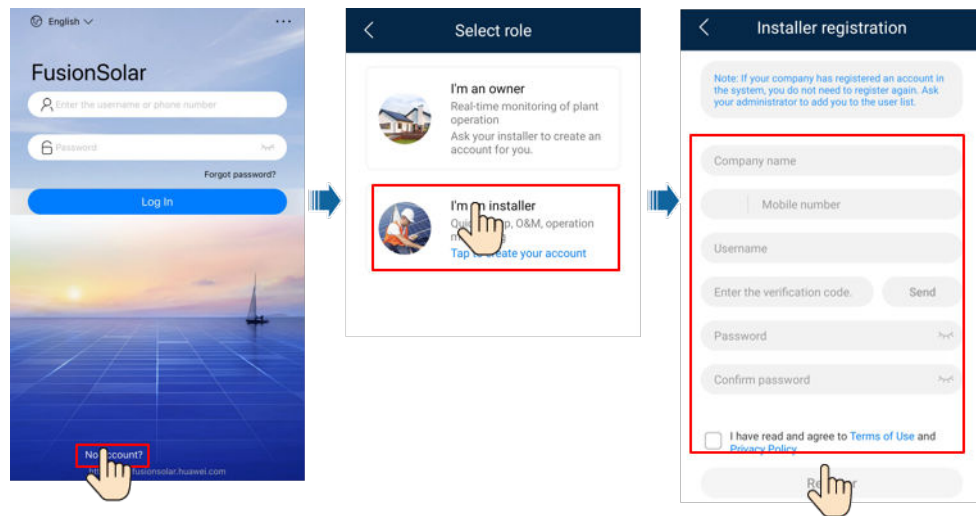

NOTICE

To create multiple installer accounts for a company, log in to the FusionSolar App and tap **Add User** to create an installer account.

Figure 4-4 Creating multiple installer accounts for the same company

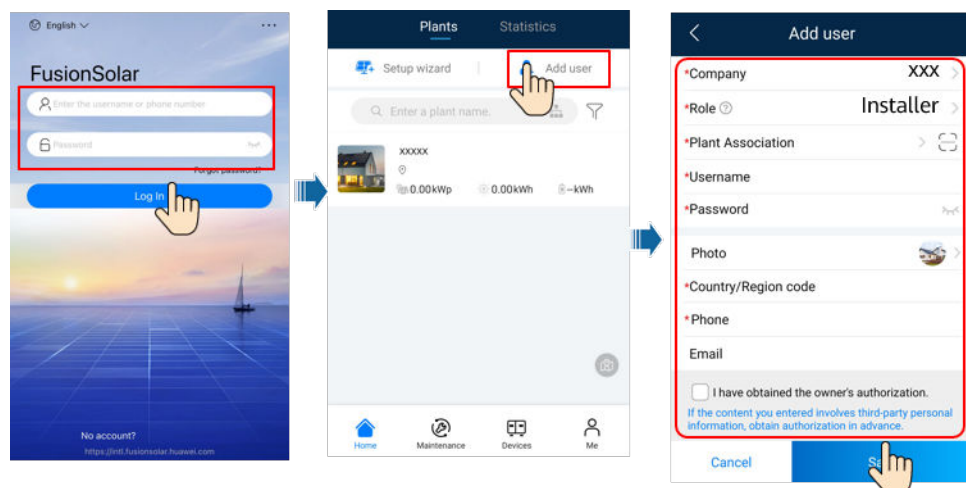

4.4 Plant Creation and Commissioning (Installer)

- After devices are installed, an installer can create a plant and configure basic information on the FusionSolar app to implement unified device monitoring and O&M.
- If a charger is added to a PV plant, you need to connect the charger to the PV plant.

Figure 4-5 Plant creation process

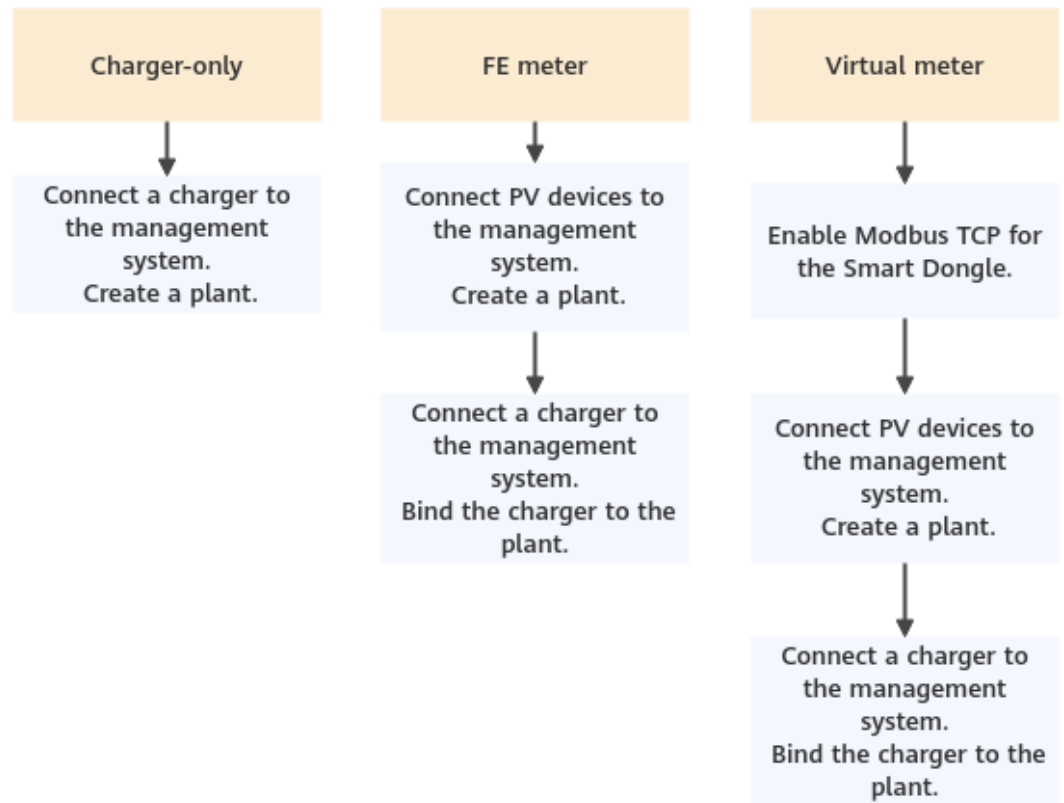

4.4.1 Charger-Only

Device Commissioning (Charger)

1. Log in to the FusionSolar app as an installer, tap **Setup wizard** on the **Home** screen, scan the QR code of the charger, and follow the instructions to connect to the charger WLAN.

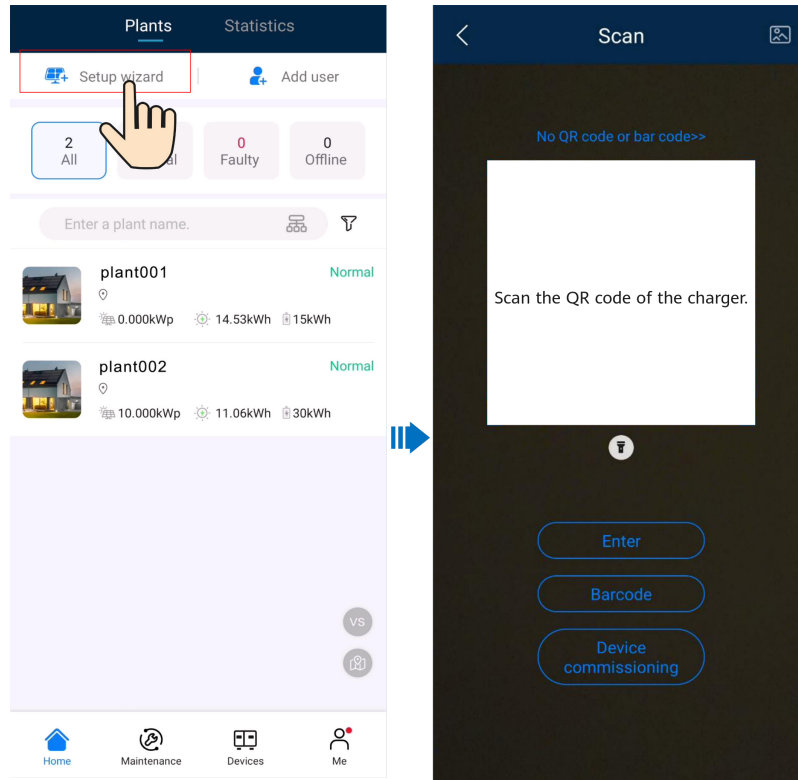

NOTE

- The last six digits of the product WLAN name are the same as the last six digits of the product serial number (SN).
 - Use the initial password upon the first power-on and change the password immediately after login. To ensure account security, protect the password by changing it periodically, and keep it secure. Your password might be stolen or cracked if it is left unchanged for extended periods. If a password is lost, devices cannot be accessed. In these cases, the Company shall not be liable for any loss.
2. Log in to the app as an **Installer**.

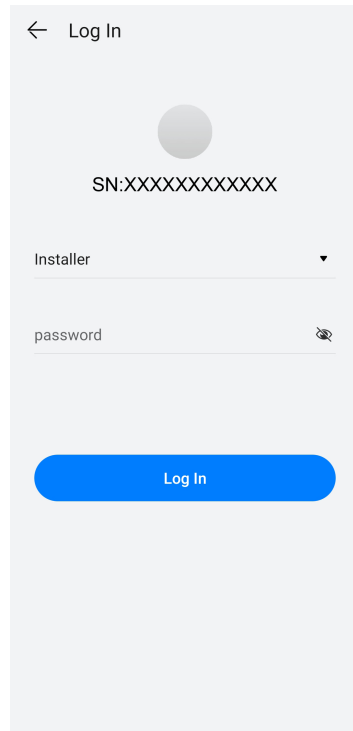

 **NOTE**

For the first login, the initial password is **Changeme**. If the system prompts you to set a password, set the login password as prompted.

3. Commission the device according to the wizard procedure. (Select the corresponding network configuration.)

Figure 4-6 Charger FE port directly connected to a meter

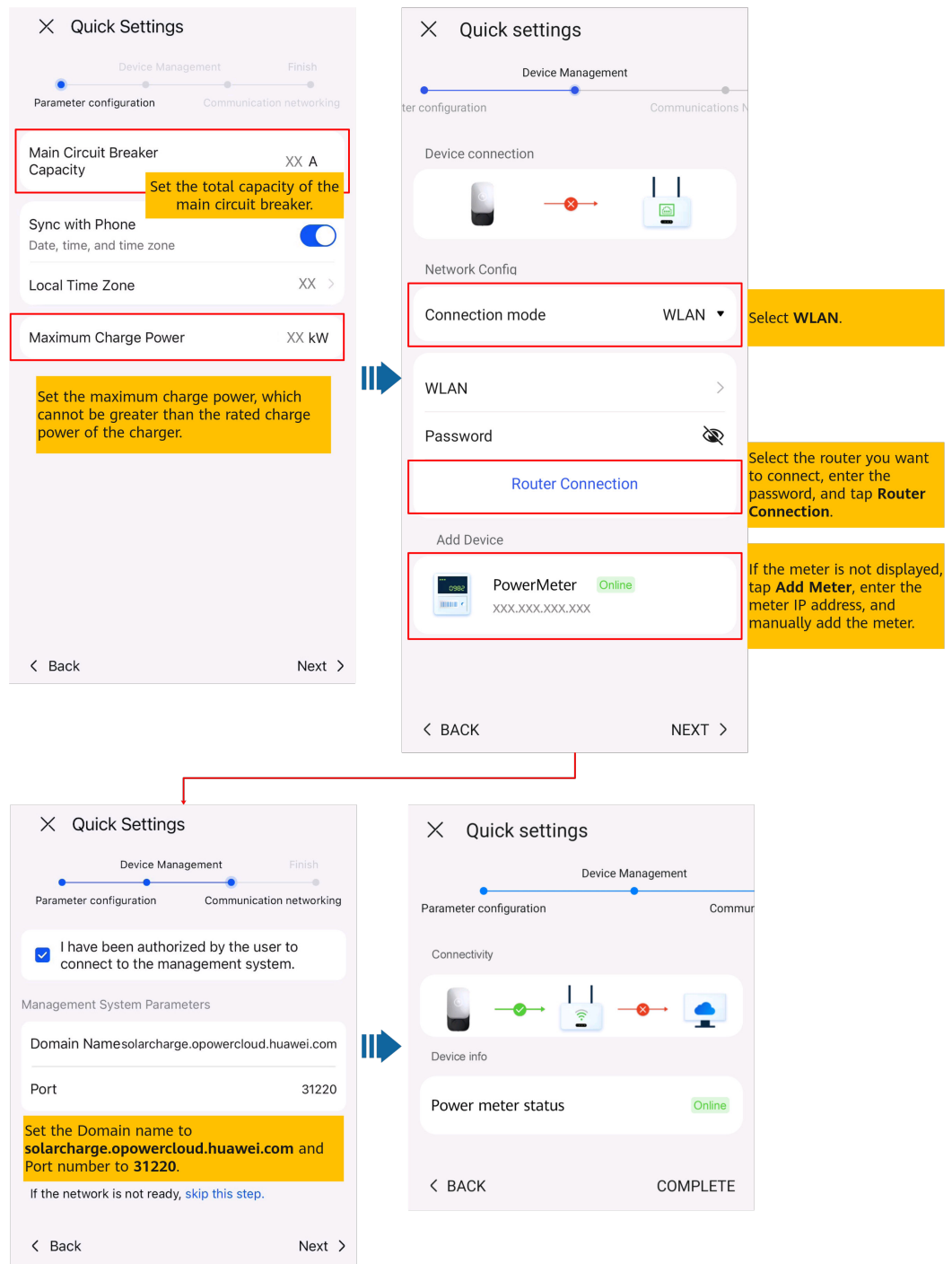

Figure 4-7 Charger FE port directly connected to a router

Step 1: Quick Settings

- Main Circuit Breaker Capacity: XX A. *Set the total capacity of the main circuit breaker.*
- Maximum Charge Power: XX kW. *Set the maximum charge power, which cannot be greater than the rated charge power of the charger.*

Step 2: Quick settings

- Connection mode: Select FE. FE
- DHCP: Enabled. *This function is enabled by default. In this case, the router automatically assigns an IP address to the charger.*
- Add Device: PowerMeter Online. *If the meter is not displayed, tap Add Meter, enter the meter IP address, and manually add the meter.*

Step 3: DHCP Configuration

DHCP	<input type="checkbox"/>
IP Address	xxx.xxx.xxx.xxx
Subnet Mask	255.255.255.0
Default Gateway	192.168.0.1
Primary DNS Server	0.0.0.0
Secondary DNS server	0.0.0.0

Step 4: Quick Settings

- Management System Parameters:
 - Domain Name: solarcharge.opowercloud.huawei.com
 - Port: 31220
 - Set the Domain name to solarcharge.opowercloud.huawei.com and Port number to 31220.*

Step 5: Quick settings

- Connectivity: [Icons for various connection types]
- Device info: Power meter status Online

Additional Notes:

- When the charger FE port is directly connected to the router, do not select WLAN. Otherwise, the meter will fail to be connected.*
- If the router does not support DHCP, disable DHCP and manually assign an IP address.*
- Enter the IP address as prompted and tap Router Connection.*

Figure 4-8 Charger connected to a router through WiFi

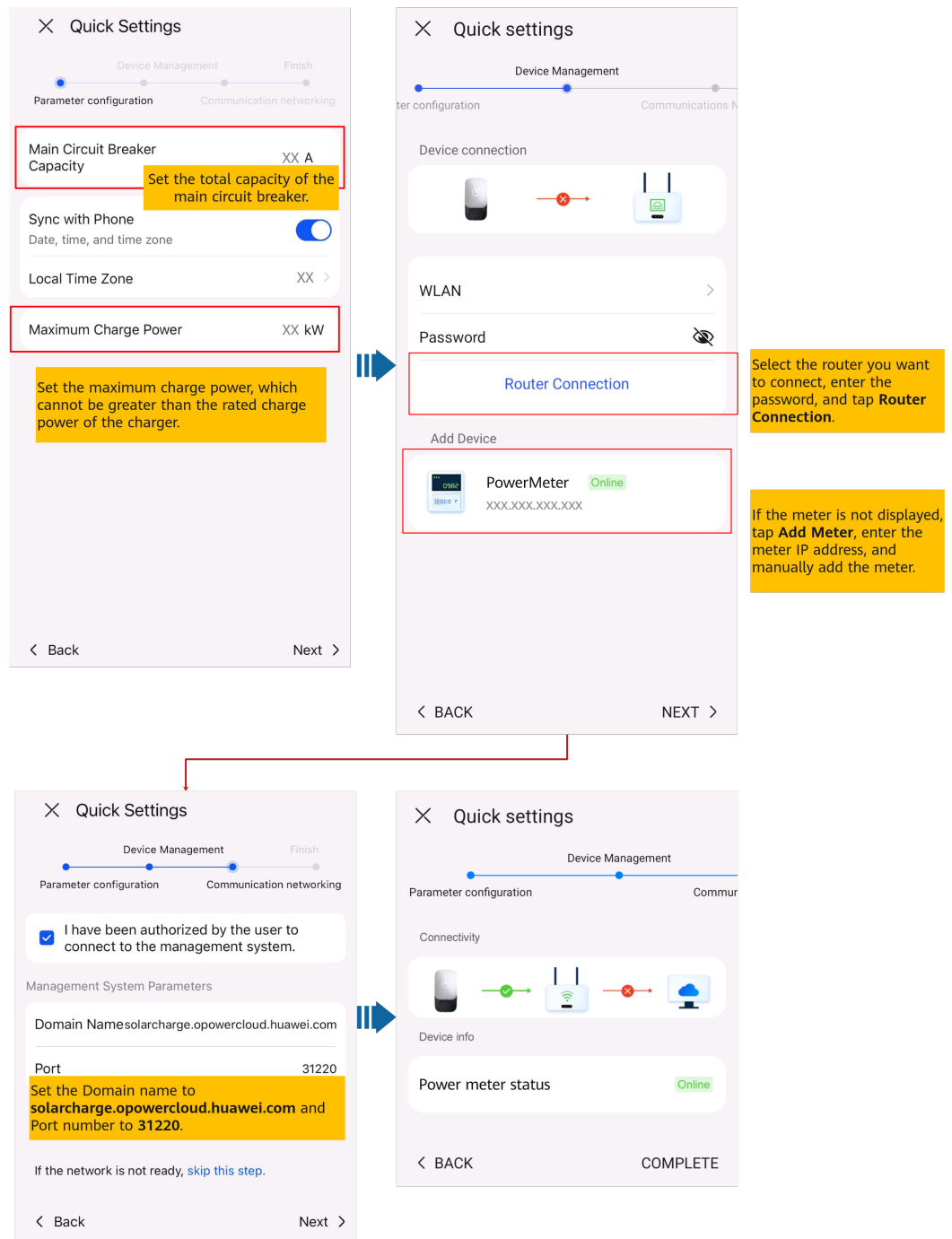

Connecting to a New Plant

After the quick settings are complete, connect devices to the new plant.

Figure 4-9 Connecting to a new plant

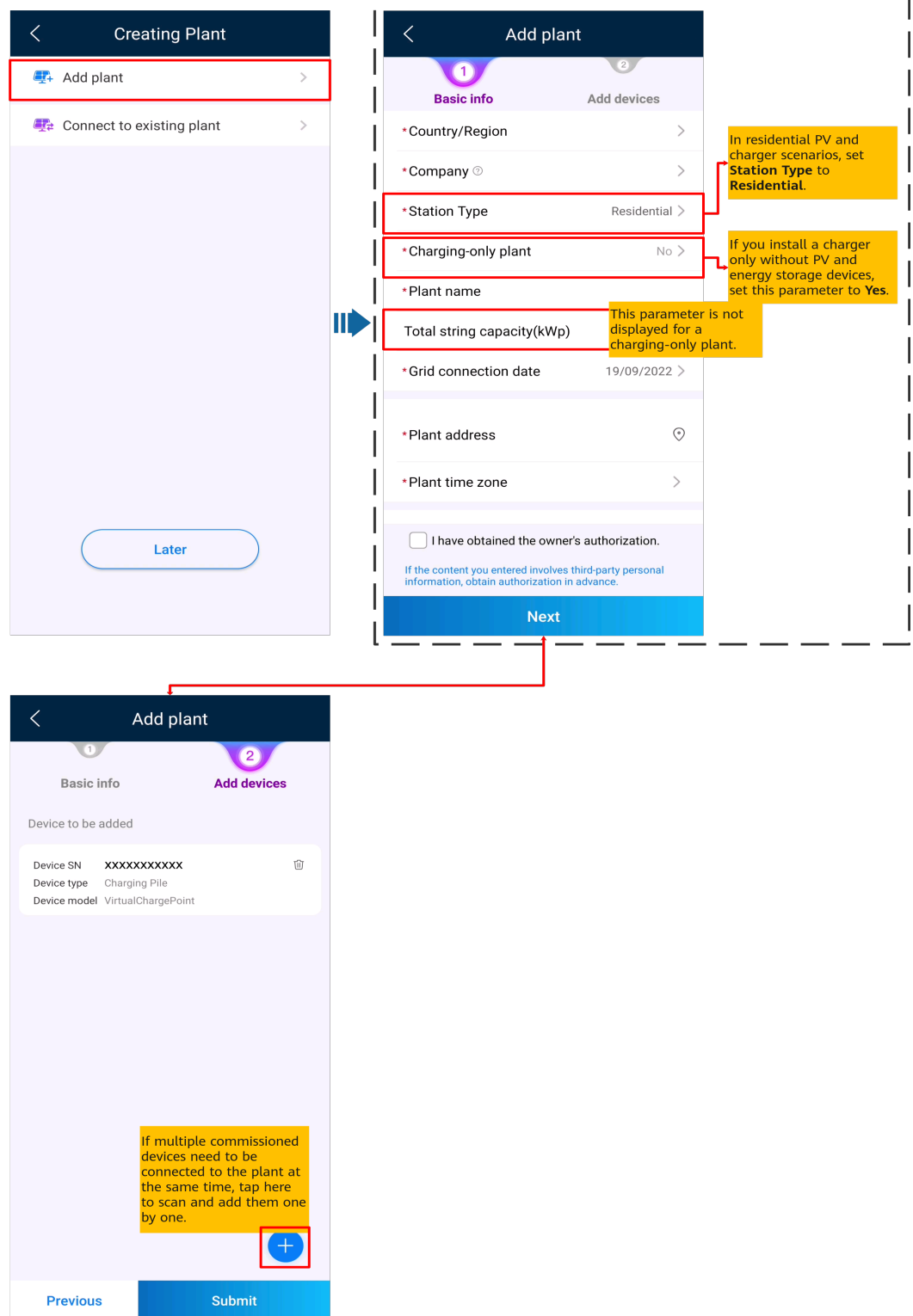

4.4.2 PV+Charger/PV+ESS+Charger

NOTE

If virtual meter networking is used, log in to the inverter connected to the Smart Dongle. On the device commissioning screen, choose **Settings** > **Communication configuration** > **Dongle parameter settings**, and set **Modbus TCP to Enable (unrestricted)**. If an FE meter is used, set **Modbus TCP to Disable**.

PV+Charger/PV+ESS+Charger Devices Under the Same Installer

1. Connect the PV and ESS devices to the management system and create a plant. For details, see the corresponding inverter quick guide or [FusionSolar App Quick Guide](#).
2. Commission the charger and connect it to the management system. For details, see [Device Commissioning \(Charger\)](#).
3. Connect the charger to the created PV plant.

Method 1: In the **Setup wizard**, scan the QR code of the charger and select **Connect to existing plant**.

Figure 4-10 Connecting to an existing plant

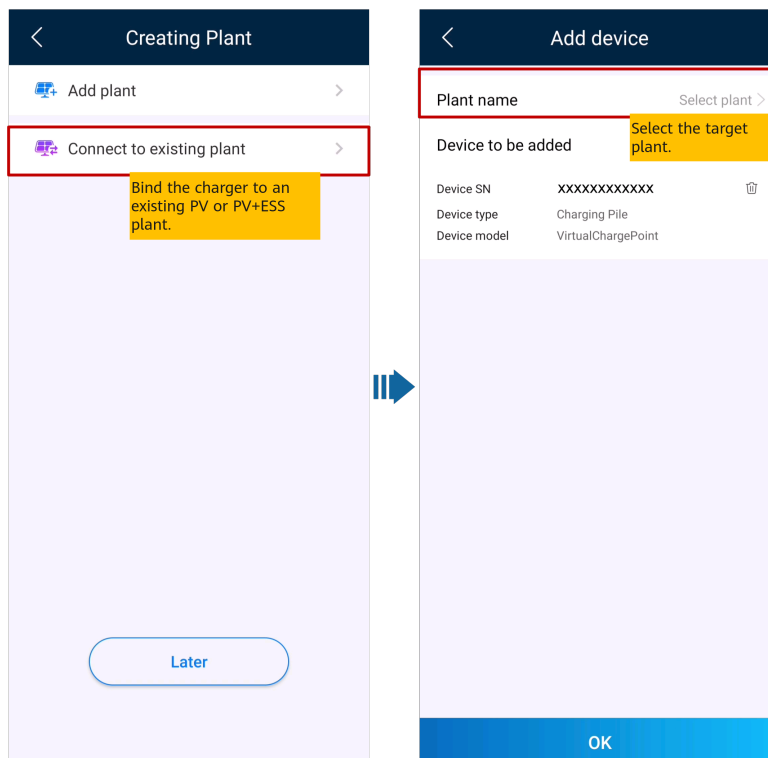

Method 2: On the **Overview** screen, tap **Add device** to connect to the charger.

Figure 4-11 Adding a device

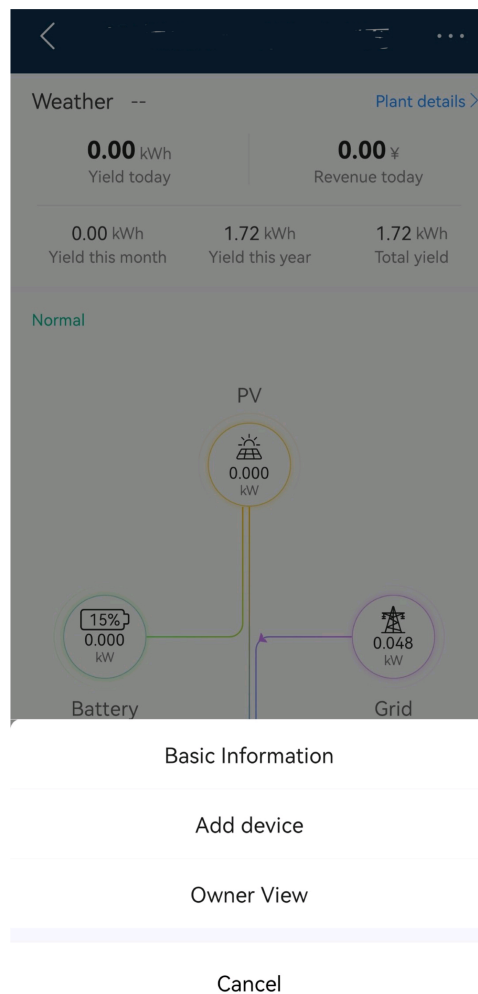

PV+Charger/PV+ESS+Charger Devices Under Different Installers

- If a PV or ESS device is added to the charger, installer A has bound the charger to a plant, and installer B adds the PV device, the charger needs to be unbound from the original plant and connected to the new PV plant created by installer B.
- If a charger is added to a PV+ESS plant and installer A does not bind the charger to the plant after commissioning, installer A can send the charger SN or QR code to installer B who connects the charger to the existing PV+ESS plant.

4.5 Using a Charger (Owner)

The FusionSolar app can connect to chargers. You can use the app to charge a vehicle, set the charging power, and charge with PV power.

4.5.1 Plug-and-Play Charging

After the charging connector is inserted into the charging port of a vehicle, the charger automatically starts and stops charging.

Precautions

- To use plug-and-play charging, disable the identity authentication by referring to **Identity Authentication** which may result in unauthorized charging.
- You can also lock the charging connector to the charger if the property safety is ensured. In this way, you only need to insert the charging connector to your vehicle to start a charging session. For details, see **Lock Charging Connector**.

Starting Charging

Insert the charging connector completely into the charger and the charging port of a vehicle. If the indicator on the charger turns blue on and off cyclically (on for 0.5s and off for 0.5s), the charger is in the charging state.

Stopping Charging

After the vehicle is fully charged, the charger automatically stops charging. In this

case, the indicator is steady blue. You can also touch and hold



on the app or swipe the RFID card in the swiping area to stop charging.

NOTE

To use plug-and-play charging, do not set scheduled charging. Otherwise, the charger enters the scheduled charging waiting state after the charging connector is inserted into the charging port of a vehicle.

4.5.2 Scheduled Charging

Charging Procedure

1. On the charger screen, tap **Scheduled Charging**.
2. Tap **Schedule**. If the indicator on the charger turns blue on and off cyclically (pulsating blue for 4s and off for 1s), the charger has entered the scheduled charging waiting state.

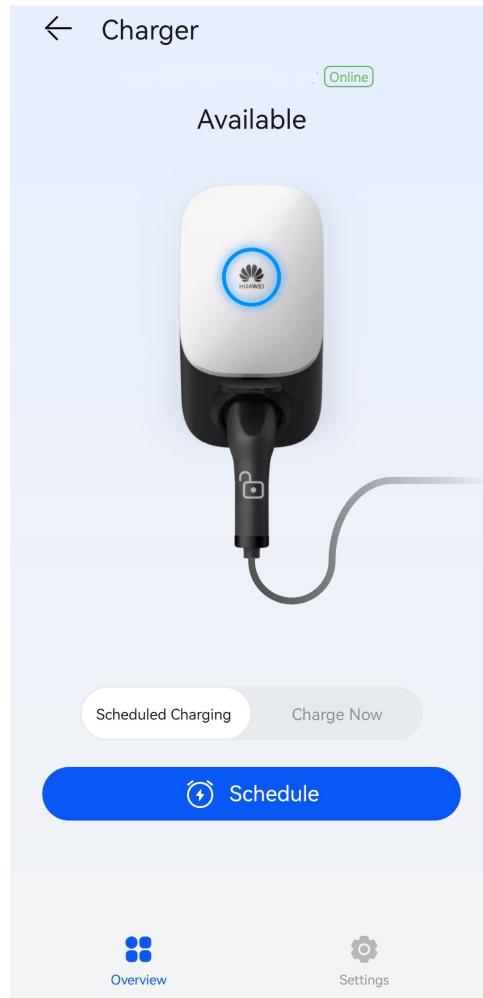

Setting the Scheduled Charging Time



1. On the charger screen, choose **Settings > Scheduled Charging**.
 - Tap  to set the charging start time and end time.
 - Tap a scheduled charging plan to edit it.

Figure 4-12 Setting a scheduled charging plan



- Select a plan you want to delete, press and swipe left, and tap  to delete the time.

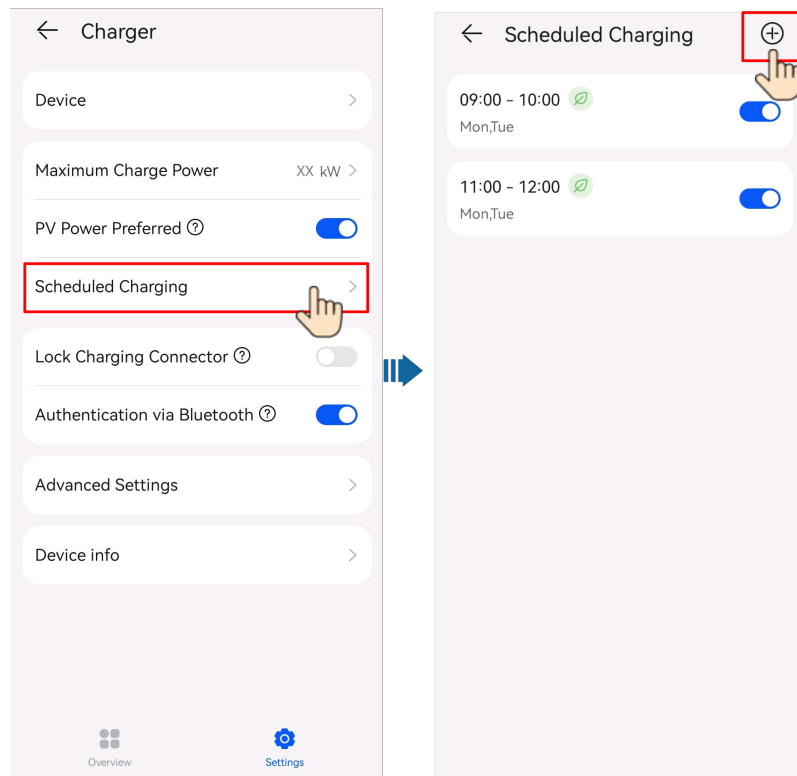

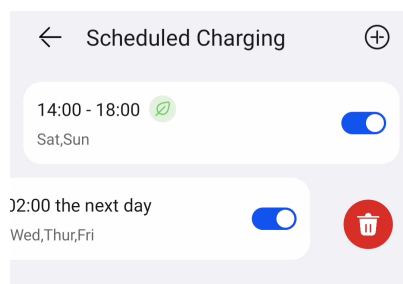
4.5.3 Starting and Stopping Charging on the App

Precautions

Before charging, you need to completely insert the charging connector into the charger and vehicle. If the indicator on the charger turns blue on and off cyclically (on for 4s and off for 1s), the charger is successfully connected to the vehicle.

Starting Charging

Log in to the FusionSolar app as an owner and tap the charger icon on the home screen. Tap **Start Charging** in **Charge Now** mode, or tap **Schedule** in **Scheduled Charging** mode.

If the indicator on the charger turns blue on and off cyclically (on for 0.5s and off for 0.5s), the charger is in the charging state. If the indicator is pulsating blue for 4s and off for 1s cyclically, the charger is in the scheduled charging waiting state.

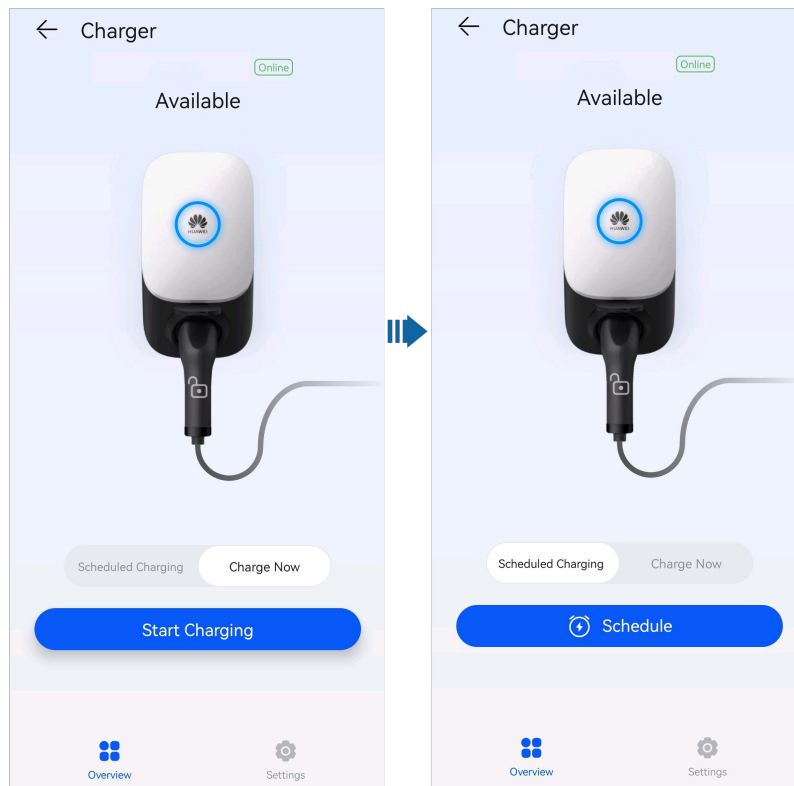

Stopping Charging

After the vehicle is fully charged, the charger automatically stops charging. In this

case, the indicator is steady blue. You can also touch and hold  on the app to stop charging.

4.5.4 Start Charging Through Bluetooth Authentication

Complete the Bluetooth pairing of the charger on the FusionSolar app. Ensure that the app is running and the Bluetooth function of the phone is enabled. When the phone is close to the charger, the identity authentication is automatically completed and the charging starts.

Precautions

- Insert the charging connector completely into the charger and the charging port of a vehicle. If the indicator on the charger turns blue on and off cyclically (on for 4s and off for 1s), the charger is successfully connected to the vehicle.
- When you use the Bluetooth authentication function for the first time, enable the Bluetooth function on your phone. Log in to the FusionSolar app as an owner, and enable **Authentication via Bluetooth** on the charger settings screen to perform Bluetooth pairing.

Figure 4-13 Enabling bluetooth authentication

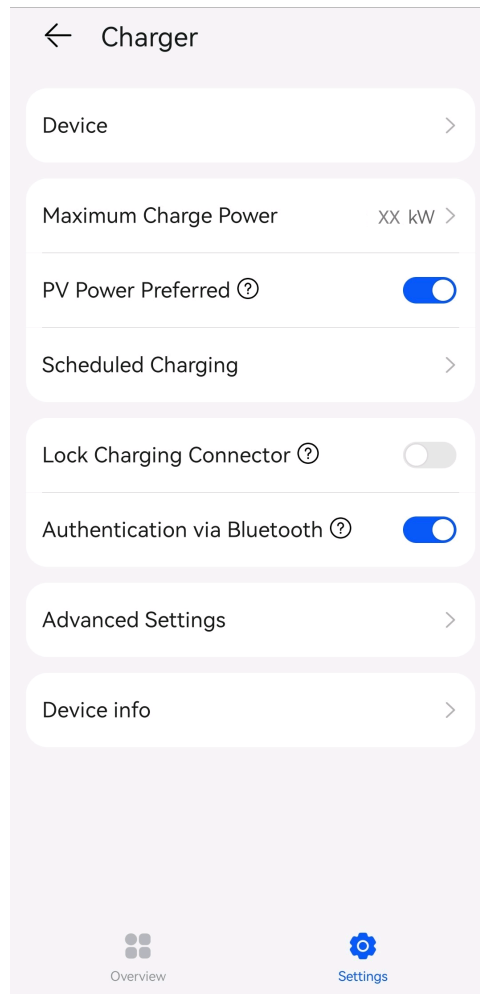

Starting Charging

- Enable Bluetooth on your phone, log in to the FusionSolar app (if you did not log out last time, simply open the app), and move your phone close to the charger to complete identity authentication and start charging.
- If the indicator on the charger turns blue on and off cyclically (on for 0.5s and off for 0.5s), the charger is in the charging state.

Stopping Charging

After the vehicle is fully charged, the charger automatically stops charging. In this

case, the indicator is steady blue. You can also touch and hold



on the app or swipe the RFID card in the swiping area to stop charging.

4.5.5 Starting and Stopping Charging Using an RFID Card

Precautions

- Before charging, make sure your RFID card has been added to the system. For details, see [Adding an RFID Card](#).
- Before charging, you need to completely insert the charging connector into the charger and vehicle. If the indicator on the charger turns blue on and off cyclically (on for 4s and off for 1s), the charger is successfully connected to the vehicle.

Starting Charging

Place the ring pattern on the RFID card in the swiping area. If the indicator blinks blue fast three times, the card is swiped successfully.

- If scheduled charging is not set, wait until the indicator on the charger turns blue on and off cyclically (on for 0.5s and off for 0.5s), indicating the charging state.
- If scheduled charging is set, the charger enters the waiting state and the indicator turns blue on and off cyclically (pulsating blue for 4s and off for 1s). The charging automatically starts at the scheduled time. You can also swipe the card again to start charging immediately.

Figure 4-14 Charging by card swiping

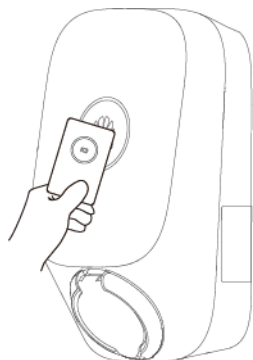

Stopping Charging

After the vehicle is fully charged, the charger automatically stops charging. In this case, the indicator is steady blue. You can also swipe the RFID card in the swiping area to stop charging.

4.5.6 Charger Settings

Plant Management

Owners can log in to the FusionSolar app to bind or unbind a charger.

1. Choose **Me > Plant management** and tap the target plant.
2. Tap **Add device**, and then tap .



3. Tap  on the right of **Device SN** to scan the QR code on the charger.
4. Tap **Save**.

Figure 4-15 Plant management for owners

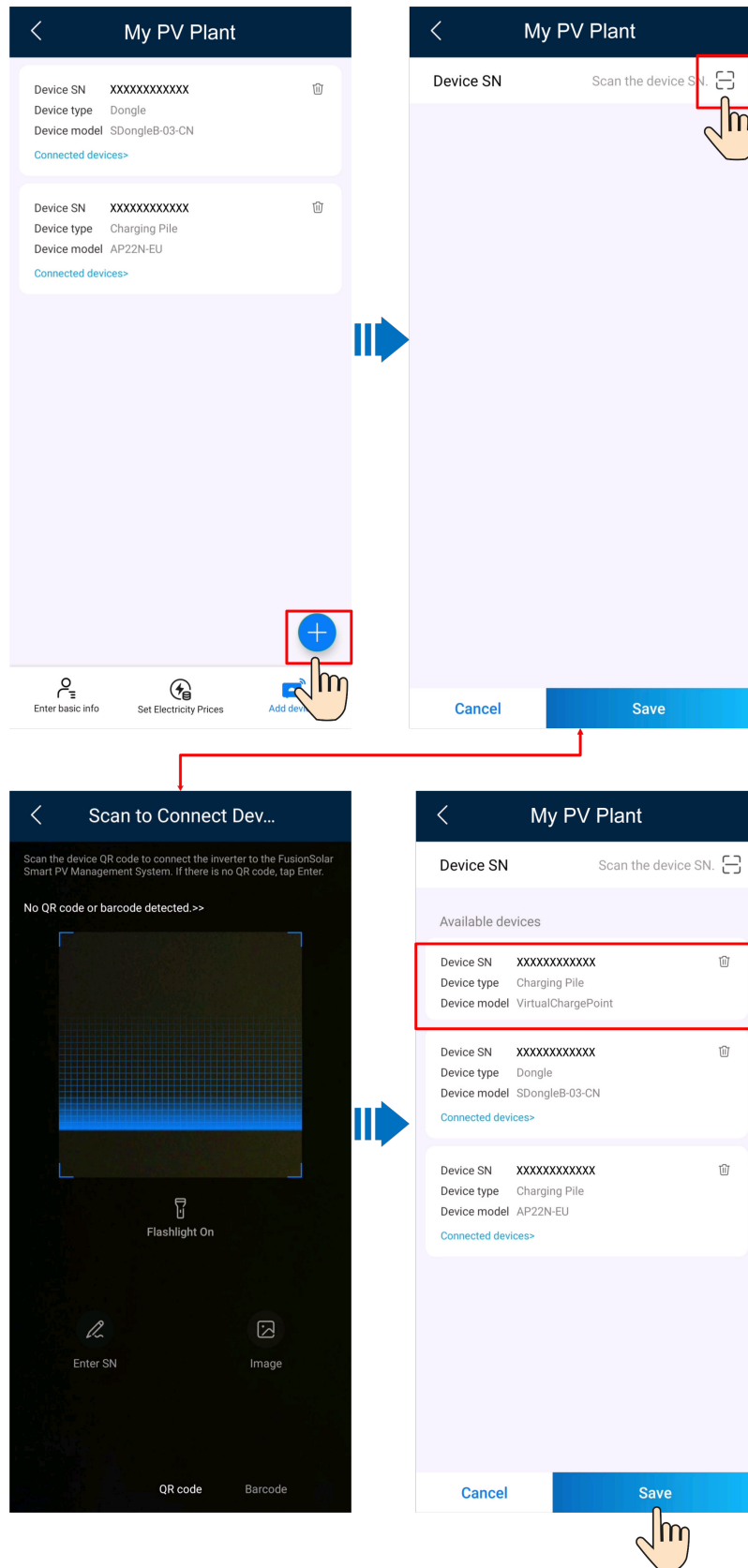

5. To unbind or delete a charger, click .

Parameters Settings

- Log in to the FusionSolar app as an owner, tap the charger icon, and set parameters. For details, see [2.2 Solution Functions and Features](#).

Figure 4-16 Parameter settings for owners

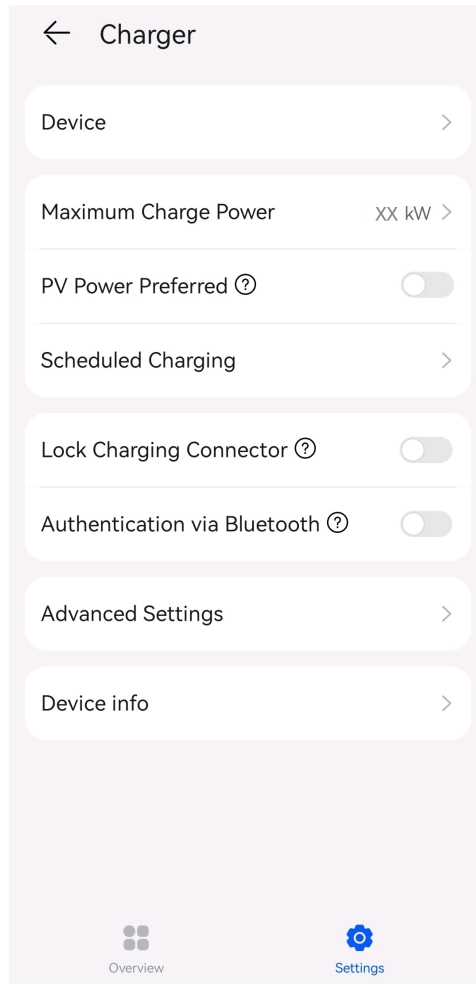

- After [connecting to the charger](#), the owner can add or delete RFID cards and query the RFID card list. For details, see [5.5 RFID Card Management](#).

5 Maintenance

 DANGER

High voltage generated by the equipment during operation may cause electric shocks, which could result in death, serious injury, or serious property damage. Before maintenance, power off the equipment, wait for a period of time according to the instructions on the delayed discharge label, and strictly follow the safety precautions in this document and related documents to operate the equipment.

5.1 Troubleshooting

For details about how to troubleshoot PV and ESS devices, see the related user manuals.

Table 5-1 Charger alarm list

No.	Component	Alarm Name	Alarm Severity	Possible Cause	Suggestion
1	Charging Connector	Charging Connector Removed Abnormally	Minor	The charging connector is removed when charging is ongoing.	Instruct the user to stop charging before removing the charging connector.

No.	Component	Alarm Name	Alarm Severity	Possible Cause	Suggestion
2	Charging Connector	Overcurrent	Minor	The charging control of the vehicle malfunctions.	<p>Step 1 Check whether an alarm is generated on the vehicle. If yes, clear the vehicle alarm and check whether the charger alarm is cleared.</p> <p>If the charger alarm is cleared, no further action is required.</p> <p>If no vehicle alarm is generated or the charger alarm persists after the vehicle alarm is cleared (if any), go to the next step.</p> <p>Step 2 Check whether the vehicle has charge current settings. If yes, set the charge current to a value less than the upper power threshold of the charger, and check whether the charger alarm is cleared.</p> <p>If the charger alarm is cleared, no further action is required.</p> <p>If no charge current settings are available or the charger alarm persists after the setting, go to the next step.</p> <p>Step 3 Restart the charger and check whether the charger alarm is cleared.</p> <p>If the charger alarm is cleared, no further action is required.</p> <p>If the charger alarm persists, go to the next step.</p> <p>Step 4 Contact the vehicle manufacturer to check whether the vehicle is faulty.</p> <p>If yes, repair the vehicle.</p> <p>If no, replace the charger.</p>

No.	Component	Alarm Name	Alarm Severity	Possible Cause	Suggestion
3	Charging Connector	Control Pilot Circuit Fault	Minor	<p>The possible causes are as follows:</p> <ol style="list-style-type: none"> 1. The charging cable connection is poor. 2. The control pilot circuit of the charging connector is faulty. 	<p>Step 1 Replace the charging connector and check whether the alarm is cleared.</p> <p>If yes, no further action is required.</p> <p>If no, go to the next step.</p> <p>Step 2 Restart the charger and check whether the alarm is cleared 1 minute later.</p> <p>If yes, no further action is required.</p> <p>If no, replace the charger.</p>
4	Charging Connector	Electric Leakage	Critical	<p>The possible causes are as follows:</p> <ol style="list-style-type: none"> 1. The charging cable is damaged. 2. The PE cable inside the vehicle is connected to the power cable. 	<p>Step 1 Check whether the charging connector is inserted into the charging port of the vehicle.</p> <p>If yes, go to the next step.</p> <p>If no, replace the charger.</p> <p>Step 2 Restart the charger, use a simulator or another vehicle for charging, and check whether the alarm persists.</p> <p>If yes, go to the next step.</p> <p>If no, the vehicle is faulty.</p> <p>Step 3 Check whether the insulation layer of the charging cable is damaged.</p> <p>If yes, replace the charging cable. If the alarm persists, replace the charger.</p> <p>If no, replace the charger.</p>

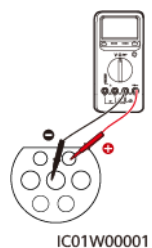
No.	Component	Alarm Name	Alarm Severity	Possible Cause	Suggestion
5	Charging Connector	Charging Connector Lock Faulty	Major	<p>The possible causes are as follows:</p> <ol style="list-style-type: none"> 1. The charging connector is not properly inserted. 2. The charging connector lock control is faulty. 	<p>Step 1 Check whether the charging connector is completely inserted into the charger port.</p> <p>If yes, go to the next step.</p> <p>If no, completely insert the charging connector into the charger port. If the alarm is cleared, no further action is required. If the alarm persists, go to the next step.</p> <p>Step 2 Use the app to deliver the lock and unlock commands twice, and check whether the alarm is cleared.</p> <p>If yes, no further action is required.</p> <p>If no, replace the charger.</p>
6	Charging Connector	Charging Cable Abnormal	Major	<p>The through-current capability of the charging cable is abnormal.</p>	<p>Step 1 Remove the charging cable. Use a multimeter to measure the PP-PE resistance and check whether the resistance is 100, 220, 680, or 1500 ohms ($\pm 3\%$).</p> <p>If yes, replace the charger.</p> <p>If no, replace the charging cable. If the alarm persists, replace the charger.</p> <p>Figure 5-1 Measuring the charging cable resistance at the charger side</p>  <p>IC01W00001</p>

No.	Component	Alarm Name	Alarm Severity	Possible Cause	Suggestion
7	AC Charger	Leakage Detection Circuit Fault	Critical	The leakage detection circuit is faulty.	Step 1 Restart the charger and check whether the charger alarm is cleared. If yes, no further action is required. If no, replace the charger.
8	AC Charger	Contactor Fault	Major	The contactor is adhered.	Step 1 Restart the charger and check whether the charger alarm is cleared. If yes, no further action is required. If no, replace the charger.
9	AC Charger	Temperature Sensor Faulty	Major	The temperature sensor is faulty.	Step 1 Restart the charger, wait for 1 minute, charge the vehicle again, and check whether the fault is rectified. If yes, no further action is required. If no, replace the charger.
10	AC Charger	Input Phase Failure	Minor	The charging cable is incorrectly connected.	Step 1 Check whether the input voltage is abnormal. If yes, rectify the mains input circuit and ensure that the voltage is normal. If the alarm persists, go to the next step. If no, go to the next step. Step 2 Restart the charger, wait for 1 minute, and check whether the alarm is cleared. If yes, no further action is required. If no, replace the charger.

No.	Component	Alarm Name	Alarm Severity	Possible Cause	Suggestion
11	AC Charger	Input Undervoltage	Minor	The mains or inverter power supply is unstable.	<p>Step 1 Check whether the input voltage is abnormal. If yes, rectify the mains input circuit and ensure that the voltage is normal. If the alarm persists, go to the next step. If no, go to the next step.</p> <p>Step 2 Restart the charger, wait for 1 minute, and check whether the alarm is cleared. If yes, no further action is required. If no, replace the charger.</p>
12	AC Charger	Input Overvoltage	Minor	The mains or inverter power supply is unstable.	<p>Step 1 Check whether the input voltage is abnormal. If yes, rectify the mains input circuit and ensure that the voltage is normal. If the alarm persists, go to the next step. If no, go to the next step.</p> <p>Step 2 Restart the charger, wait for 1 minute, and check whether the alarm is cleared. If yes, no further action is required. If no, replace the charger.</p>

No.	Component	Alarm Name	Alarm Severity	Possible Cause	Suggestion
13	AC Charger	High Temperature	Minor	<p>The possible causes are as follows:</p> <ol style="list-style-type: none"> 1. The ambient temperature of the charger is too high. 2. The cable is short-circuited. 	<p>Step 1 Check whether the charger is exposed to strong sunlight.</p> <p>If yes, shield the charger from direct sunlight. If the alarm persists, go to the next step.</p> <p>If no, go to the next step.</p> <p>Step 2 Check whether there are heat sources around.</p> <p>If yes, keep the charger away from heat sources. If the alarm persists, go to the next step.</p> <p>If no, go to the next step.</p> <p>Step 3 Check whether the ambient temperature is lower than 40°C.</p> <p>If yes, replace the charger when the alarm persists.</p> <p>If no, restart the charger after the ambient temperature drops. Wait for 1 minute and check whether the alarm is cleared. If the alarm persists, replace the charger.</p>
14	AC Charger	Cable Connection Abnormal	Critical	<p>The possible causes are as follows:</p> <ol style="list-style-type: none"> 1. The charger is not grounded. 2. The live wire and neutral wire are reversely connected. 	<p>Step 1 Check whether the charger is properly grounded.</p> <p>If yes, go to the next step.</p> <p>If no, contact your electrician to ground the charger correctly.</p> <p>Step 2 Contact the electrician to check whether the live wire and neutral wire are reversely connected (by checking whether the voltage between the PE wire and neutral wire is greater than 60 V).</p> <p>If yes, contact your electrician to connect the wires correctly.</p> <p>If no, replace the charger.</p>

No.	Component	Alarm Name	Alarm Severity	Possible Cause	Suggestion
15	AC Charger	Certificate Expired	Major	<p>The possible causes are as follows:</p> <ol style="list-style-type: none"> 1. The charger system time is incorrectly set. 2. The charging controller certificate has expired. 	<p>Step 1 Check whether the system time is incorrectly set. If yes, reset or synchronize the system time. Wait for 1 hour and check whether the alarm is cleared. If the alarm persists, go to the next step. If no, go to the next step.</p> <p>Step 2 Apply for a new certificate. If you cannot apply for a new certificate, contact technical support.</p> <p>Step 3 Import the new certificate and check whether the alarm is cleared. If yes, no further action is required. If no, replace the charger.</p>
16	AC Charger	Certificate Will Expire	Major	<p>The possible causes are as follows:</p> <ol style="list-style-type: none"> 1. The difference between the charger system time and the expiration time of the charging host certificate is less than 90 days. 2. The system time is incorrectly set. 	<p>Step 1 Check whether the system time is incorrectly set. If yes, reset or synchronize the system time. Wait for 1 hour and check whether the alarm is cleared. If the alarm persists, go to the next step. If no, go to the next step.</p> <p>Step 2 Apply for a new certificate. If you cannot apply for a new certificate, contact technical support.</p> <p>Step 3 Import the new certificate and check whether the alarm is cleared. If yes, no further action is required. If no, replace the charger.</p>

No.	Component	Alarm Name	Alarm Severity	Possible Cause	Suggestion
17	Meter	Communications Failure	Major	<p>The possible causes are as follows:</p> <ol style="list-style-type: none"> 1. The configuration in the direct connection scenario is incorrect. 2. The router connection or configuration is abnormal. 	<p>Scenario 1: FE meter directly connected to the charger through a network cable</p> <ol style="list-style-type: none"> 1. Set the network connection mode of the charger to WLAN (Quick settings > Connection mode). 2. Restart the charger. 3. Replace the charger. <p>Scenario 2: FE meter connected to a router.</p> <ol style="list-style-type: none"> 1. Check that the charger is connected to the router. 2. Check that the meter is properly connected to the router. 3. Enable the DHCP function on the router. 4. Restart the charger. 5. Replace the charger. <p>Scenario 3: RS485 meter and Dongle connected to a router</p> <ol style="list-style-type: none"> 1. Check that the charger is connected to the router. 2. Check that the Dongle is properly connected to the router. 3. Enable the DHCP function on the router. 4. Check that the Modbus interface of the Dongle is enabled. 5. Restart the charger. 6. Replace the charger.

5.2 Connecting to a Charger

1. Log in to the FusionSolar app and tap **Me > Device Commissioning**.
2. Tap **Charger** and connect to the WLAN of the charger as prompted.

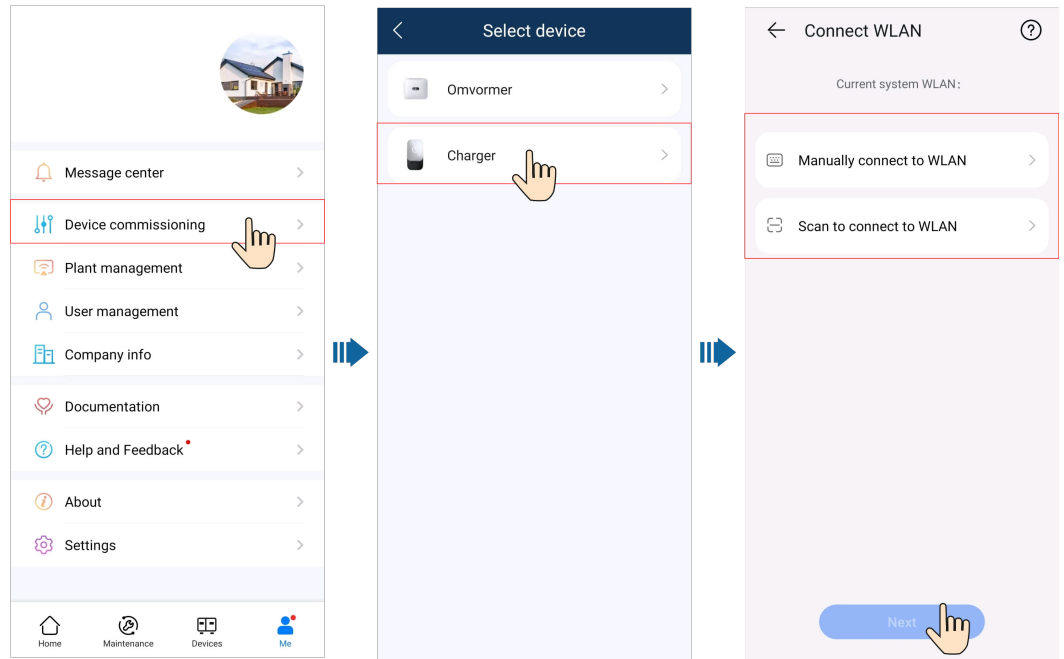

NOTE

- The last six digits of the product WLAN name are the same as the last six digits of the product SN.
- Use the initial password upon the first power-on and change the password immediately after login. To ensure account security, protect the password by changing it periodically, and keep it secure. Your password might be stolen or cracked if it is left unchanged for extended periods. If a password is lost, devices cannot be accessed. In these cases, the Company shall not be liable for any loss.

3. Log in to the app as an **Installer** or **Owner**.

NOTE

For the first login, the initial password is **Changeme**. If the system prompts you to set a password, set the login password as prompted.

Figure 5-2 Connecting to a charger

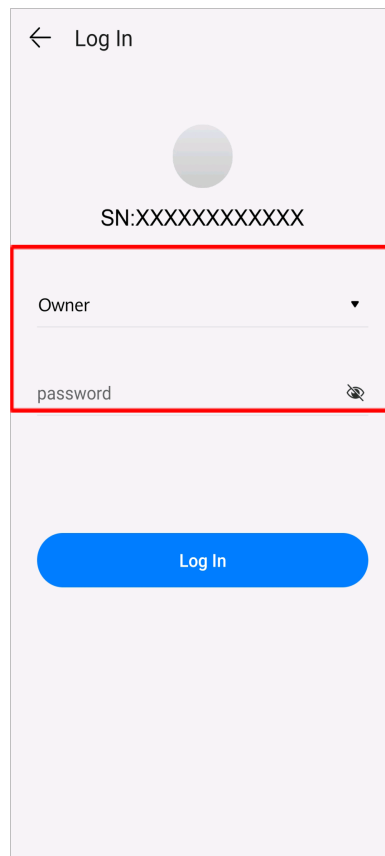

5.3 Exporting Logs and Performing an Update

1. On the home screen of the app, tap **Maintenance** to set charger running parameters, export logs, and change passwords.
 - **Log Export:** Export app operation logs and charger run logs.

NOTE

If log export is abnormal or failed, try again.

2. When receiving an update notification in the message center, you can authorize the device update.

Figure 5-3 Device update

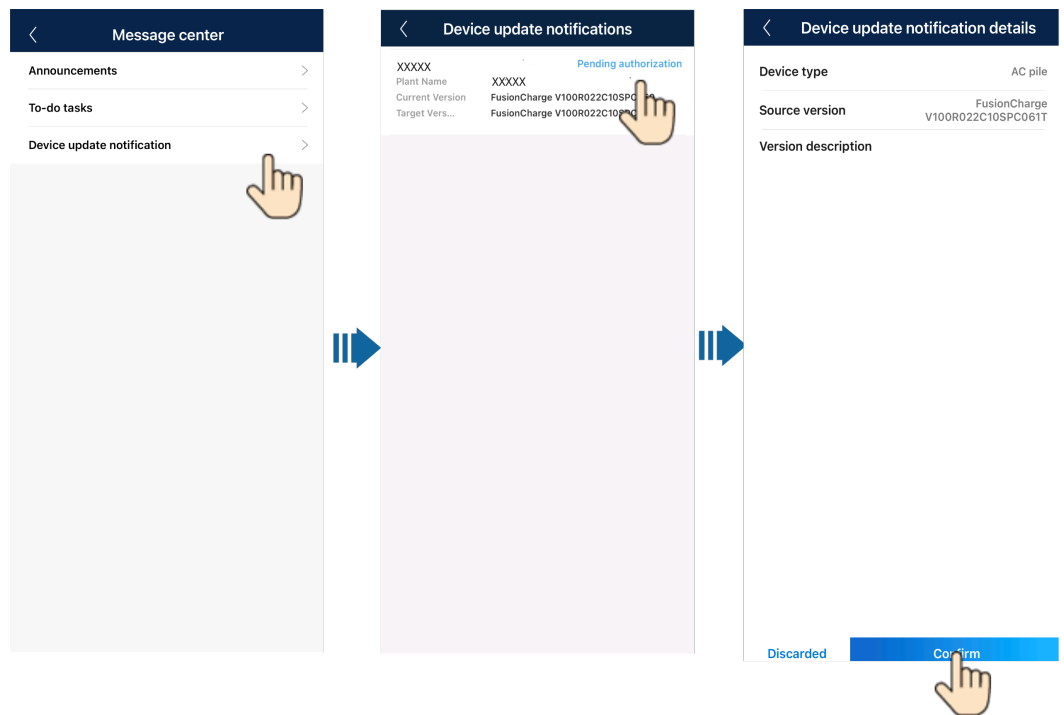

NOTE

The charger cannot be updated when it is in the charging or charging waiting state.

5.4 Resetting Charger Passwords

Description

If you forgot the password, you can reset the password by swiping the card.

Precautions

- This operation will reset both the WLAN password and login password. The charger login password will be reset to **Changeme**. The WLAN connection password will be reset to the initial password. The password for connecting the charger to the router will be deleted and needs to be reconfigured.
- Before resetting the passwords, ensure that the charger is idle.

Procedure

1. Swipe the card for five consecutive times (at an interval of less than 5s). The indicator on the charger is steady white for 3s and the charger enters the swipe protection state. Stop swiping the card now.
2. After 3s, the indicator blinks white fast for 20s. If you swipe the card again within this 20s, the indicator turns off and pulsates after 3s, indicating that the charger password has been successfully reset.

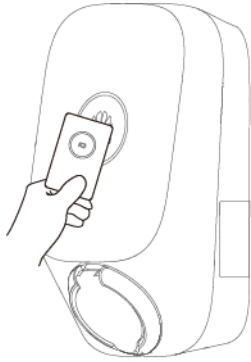

 **NOTE**

If you swipe your card in the swipe protection state, the swipe protection time will start again.

5.5 RFID Card Management

You can add or delete RFID cards and query the RFID card list on the FusionSolar app. After adding an RFID card and enabling identity authentication, you can start or stop charging by swiping the RFID card.

 **NOTE**

Before using an RFID card, choose **Settings > Advanced Settings > Identity Authentication**, and enable **Identity Authentication**. For details about the **Identity Authentication**, see [Identity Authentication](#).

Adding an RFID Card

1. [Connect to a charger](#).
2. On the **Charger** screen, choose **Settings > Card management**.
3. In the upper right corner of the **Card Management** screen, tap  and select a card adding mode.
 - **Swiping**
 - i. After the indicator blinks white fast twice, place the ring pattern on the RFID card in the swiping area. If the indicator is steady white for 5s, the card is successfully swiped.
 - ii. Enter the user-defined card name and tap **Confirm**.

Figure 5-4 Swiping



- Manually adding
Enter the card number and user-defined name of the RFID card, and tap **Confirm**.

Figure 5-5 Manually adding

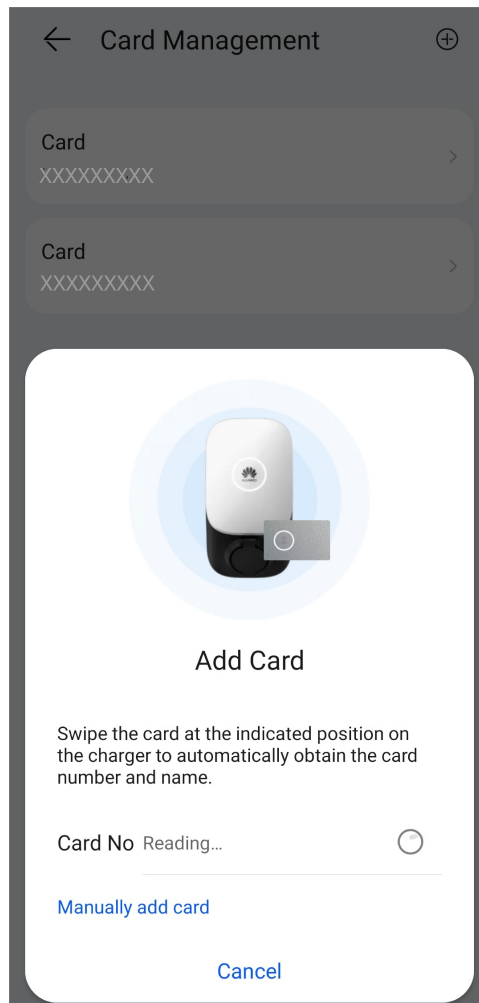
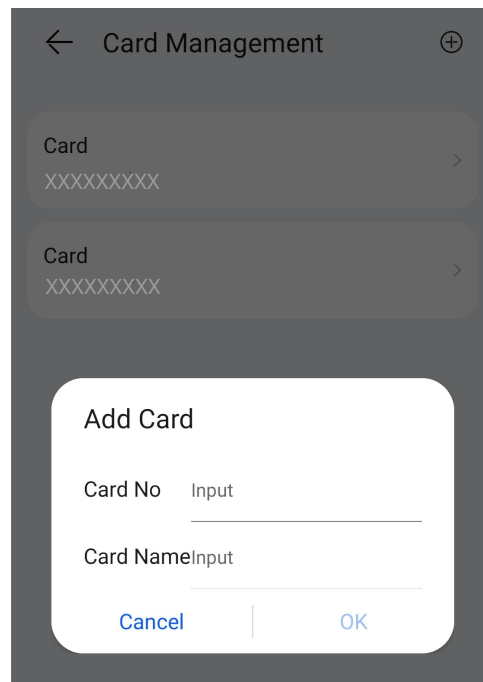

NOTE

A maximum of eight RFID cards can be added to each charger.

Deleting an RFID Card

1. Select the card you want to delete, and then press and swipe left.
2. Tap  to delete the card.

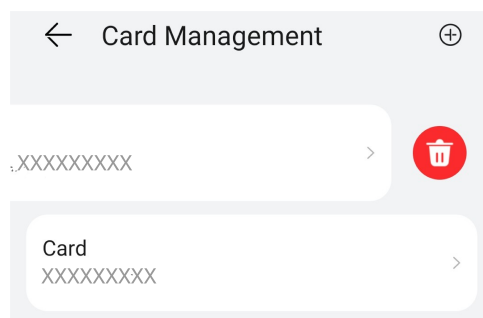

NOTE

You cannot delete all added RFID cards. At least two RFID cards must be retained.

5.6 Restoring Factory Settings

NOTE

Before restoring factory settings, unbind the charger from the plant. After factory settings are restored, connect the charger to the plant.

After factory settings are restored, app login and WLAN passwords, alarms, and management system access password of the charger will be cleared.

Log in to the FusionSolar app as an installer. After **connecting to the charger**, tap **Restore factory settings** on the maintenance screen.

Figure 5-6 Installer maintenance

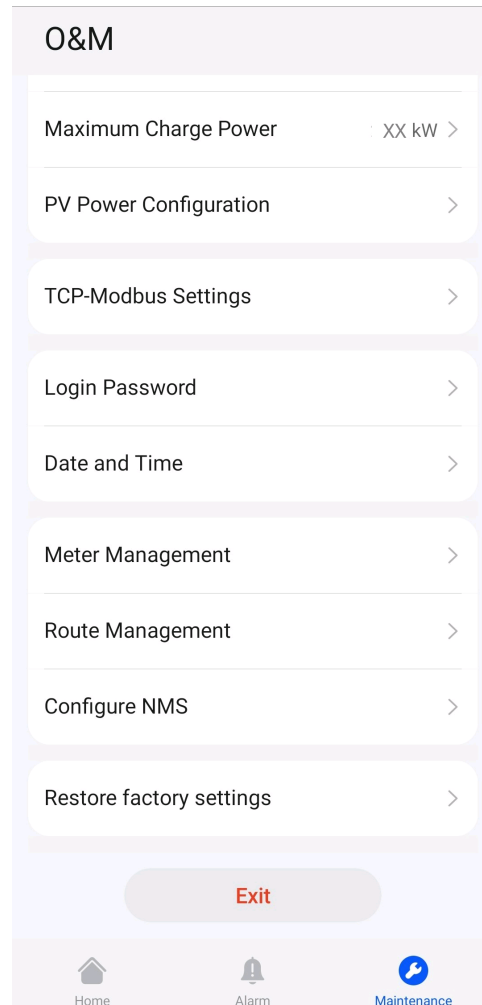

Log in to the FusionSolar app as an owner, **connect to the charger**, choose **Settings > Advanced Settings**, and tap **Restore factory settings**.

Figure 5-7 Owner settings

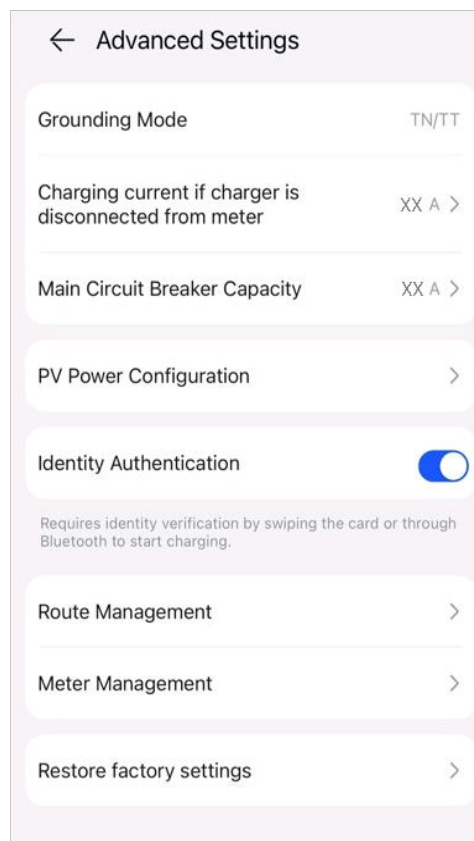

Exception Description

If the factory settings are restored without unbinding the charger from the PV plant, the charger will go offline in the management system after power-on and power-off or network disconnection recovery. In this case, you need to unbind the charger from the plant and then bind it again to restore the communication.

Step 1 Power off the charger.

Step 2 On the management system, click **Unbind**. The charger is now disconnected from the management system, and a message is displayed indicating that the password fails to be reset. Ignore the message and click **Confirm** again.

Figure 5-8 Confirming an exception message

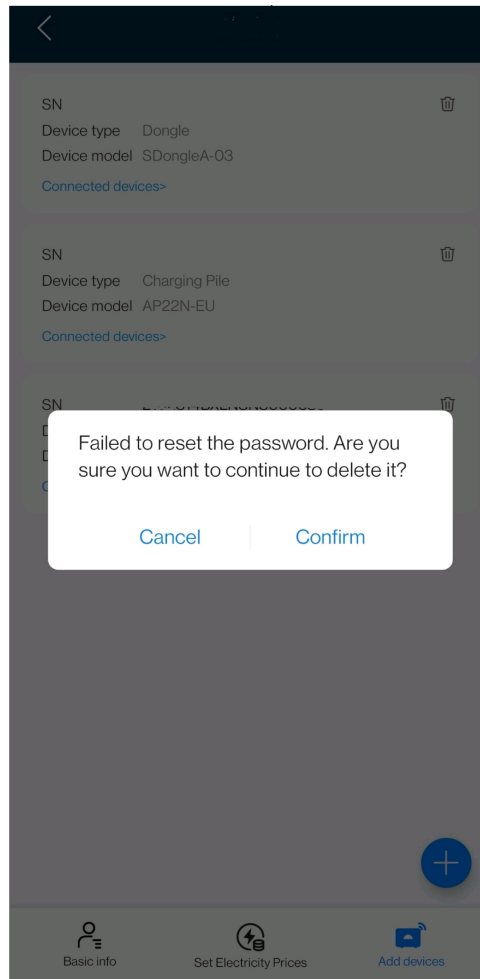

Step 3 Power on the charger again and connect it to the plant.

----End